

P R E S T O N B A I R D

2024

P R E S T O N B A I R D

F E R R O U S

F E R R O U S

P R E S T O N B A I R D

F E R R O U S

To the reader,

This is a comprehensive collection of a year of hard work, personal growth and architectural discovery, culminating in an in-depth design project. I have come away from this project knowing far more than I thought I would learn and have pushed my skills past what I thought I was capable of. I greatly appreciate the intellectual contributions and insistent guidance by my professors and fellow students. They helped me develop a passion for this project and appreciate both a persistent curiosity and an obsessive attention to detail. I hope you enjoy it as much as I did.

To my wonderful fiancé,

Thank you for your contagious positivity and ceaseless encouragement. Your consistent presence and support have pushed me the extra mile to make the most of this project, and to try and enjoy it along the way, even when I could not see the forest for the trees. I owe you a debt of gratitude for so many late nights and thoughtful discussions that showed not only your interest in understanding what this project means to me, but that you wanted to see it succeed and help in any way that you could.

Preston Baird

PRESTON BAIRD '22 '24
TEXAS A&M UNIVERSITY
SCHOOL OF ARCHITECTURE

COMMITTEE

BRIAN GIBBS – COMMITTEE CHAIR

Assistant Professor of the Practice

MARCEL ERMINY – STUDIO PROFESSOR

Assistant Professor of Practice

RAY HOLLIDAY III – COMMITTEE MEMBER

Assistant Professor of Practice

TIM EARLY – COMMITTEE MEMBER

*MLPD Program Coordinator
Associate Professor of the Practice*

TABLE OF CONTENTS

1 2 3 4

POSITION
06 – 09

FUSION
12 – 21

COHESION
22 – 85

RESOLUTION
86 – 93

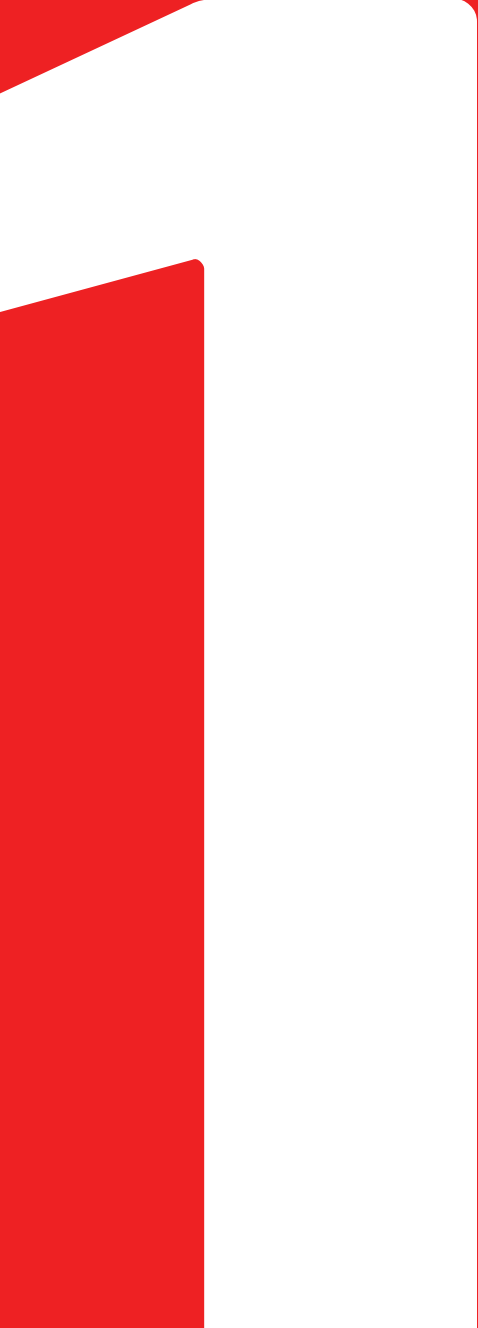

POSITION

THE ISSUE

The construction industry is particularly affected by the declining availability and overall quality of skilled trades. Carpentry, welding, plumbing and many other trades contribute their expertise to the completion of buildings. When combined with complications caused by the pandemic and poor economic conditions, the problems caused by a shortage of skilled tradespeople are widespread and have a ripple effect across other industries when the jobs they are being sought after to complete are delayed or unfinished. One survey found that “91% of firms are having trouble staffing jobsites,” a concerning metric when considering the sheer volume of construction that is taking place at any given time.

Although some efforts have been made through campaigns and policies to revitalize the trades, the outcomes may not be enough to make a significant impact and their effects will not be realized overnight. Skilled trades often provide many benefits, including paid on-the-job training, union benefits and opportunities to earn up to six figures, to name a few. Despite the many benefits that come with being in a skilled trade, young people are not replacing those that are aging out. Many young people lack the work ethic and supporting skill sets to become successful tradespeople, and the compelling idea of a four-year degree makes recruiting for trade programs even more difficult. These issues call for a new look at the approach to training the next generation of skilled tradespeople that are desperately needed to fill the shoes of those retiring.

Though most any skilled trade would benefit from a facility of this type, my interest in welding and its wide range of applications both within and outside the construction industry called for a welding school to be the building typology. This project provides the Brazos Valley with a flagship learning facility that serves to educate both high schoolers and adults in the welding trade. It leverages a building design intentionally planned around the concept of being a learning structure, with materials and structural connections serving as educational exhibits for students to learn from. It is contained in a square footprint and internally organized by a grid system, coming together to create what has become a “rigorous box,” strong and rigid in its construction yet versatile in its usability, much like a weld.

THE GOALS

The Brazos Valley Welding School is designed to be a flagship training center and resource to provide access to these benefits to not only the local school district, but to students in the broader Brazos Valley area. Two of the main goals of the project are:

- Make intentional choices in positioning and planning this project to create a building that serves as a teaching device through its tectonic expression.
- Leverage the structural grid to express the functions of the building and allow them to operate more efficiently.

2

EUSSION

SITE

BRYAN, TEXAS

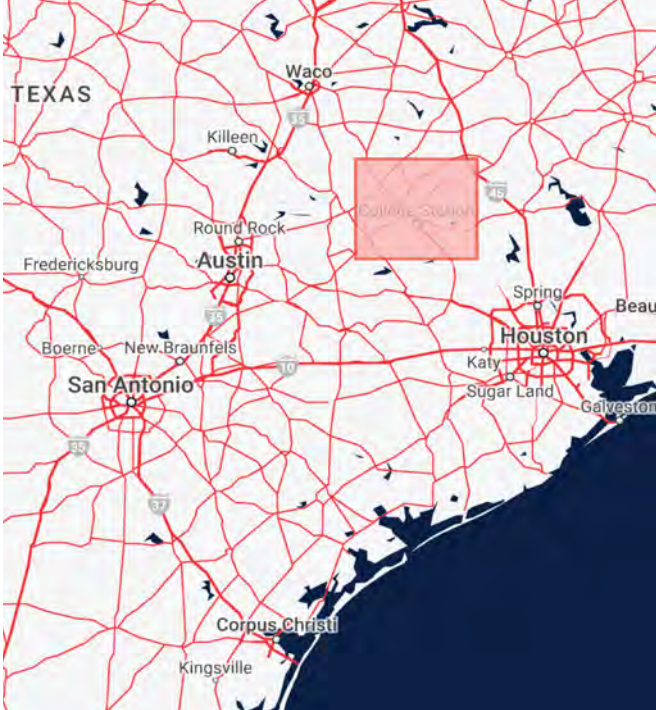
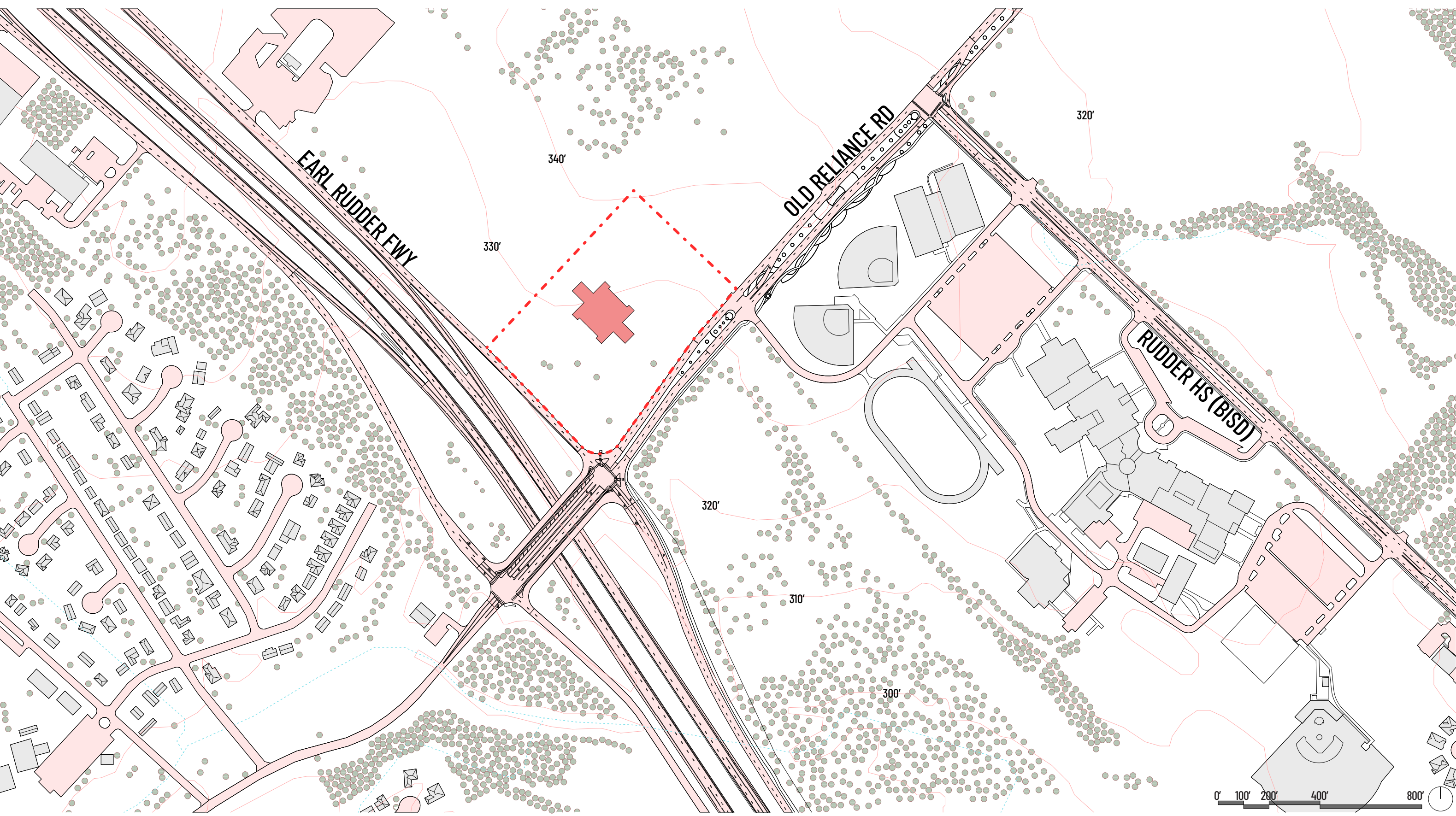

The site is located at the corner of Earl Rudder Freeway and Old Reliance Road in Bryan, Texas, close to Earl Rudder High School, one of Bryan ISD's high schools.

After competing with various locations in both larger and smaller cities, this site prevailed for its proximity to a high school and for its easy access to major roads. It lacks heavy competition compared to larger city locations, yet has significant immediate and surrounding populations from which to draw students.



The site is visible and provides multiple opportunities for entry and exit. The site is mostly flat with a few trees and a high voltage above-ground electrical line that crosses through the site near the northeast property line. An existing driveway has been utilized as a site entrance, providing a four-way intersection that connects to the rear of Rudder High School. An additional driveway on the freeway frontage road was added to facilitate fire truck access, entry for future developments and as an additional entry/exit for deliveries, trash collection and other users.

The property is 27 acres, but this project has subdivided this land and only uses 10 acres at the south corner of the property. Given the large amount of land remaining after the building footprint was solidified, there are opportunities to master plan a campus with additional buildings.

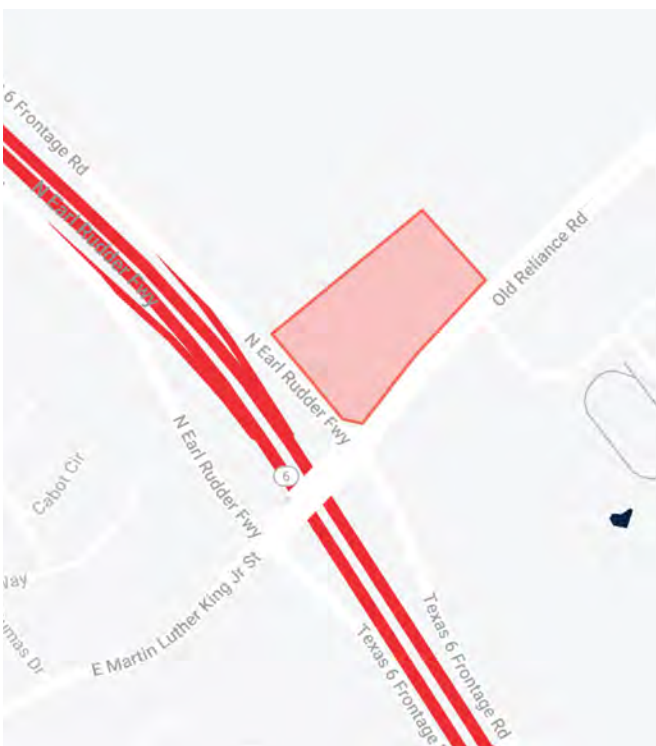

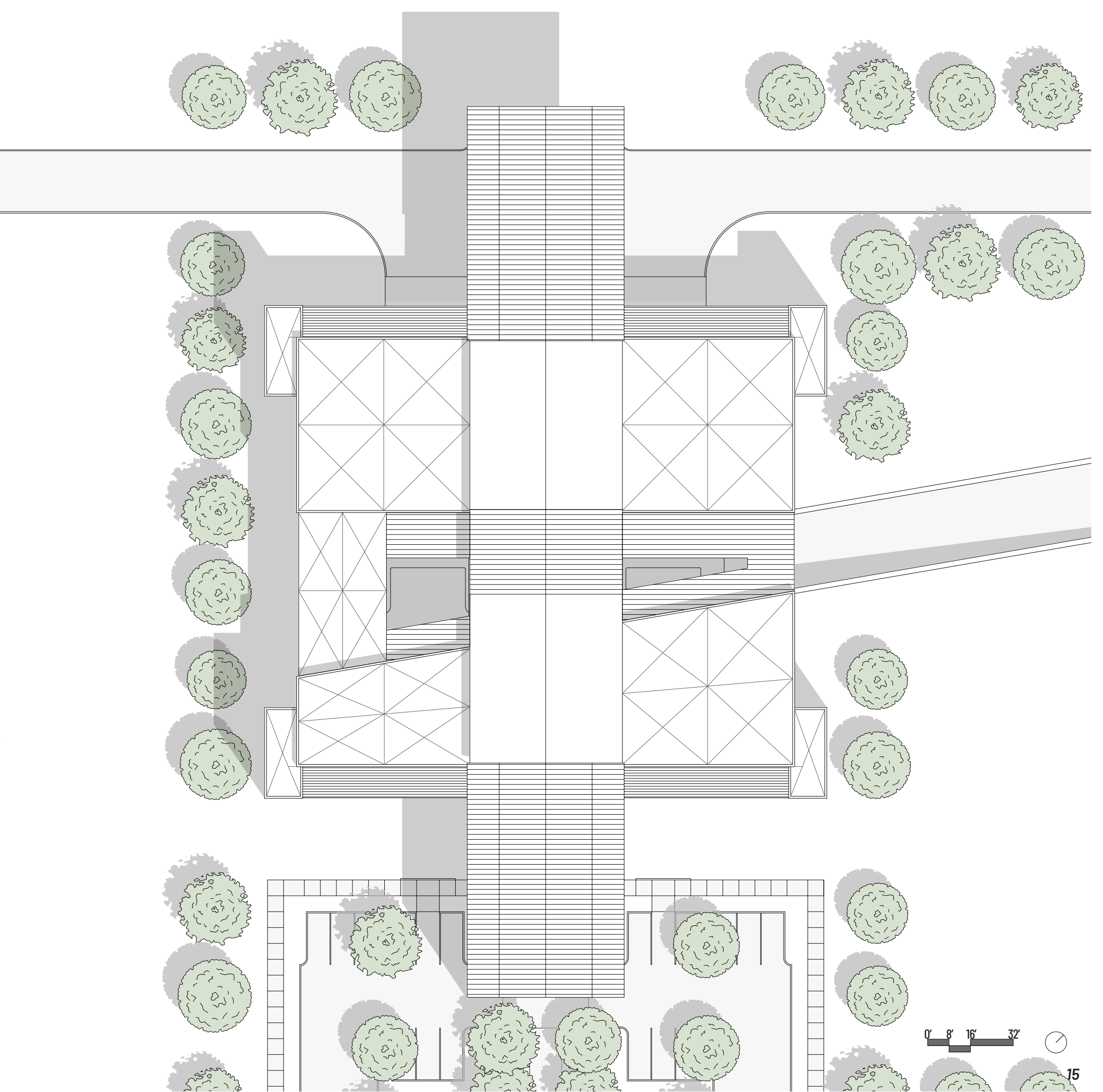
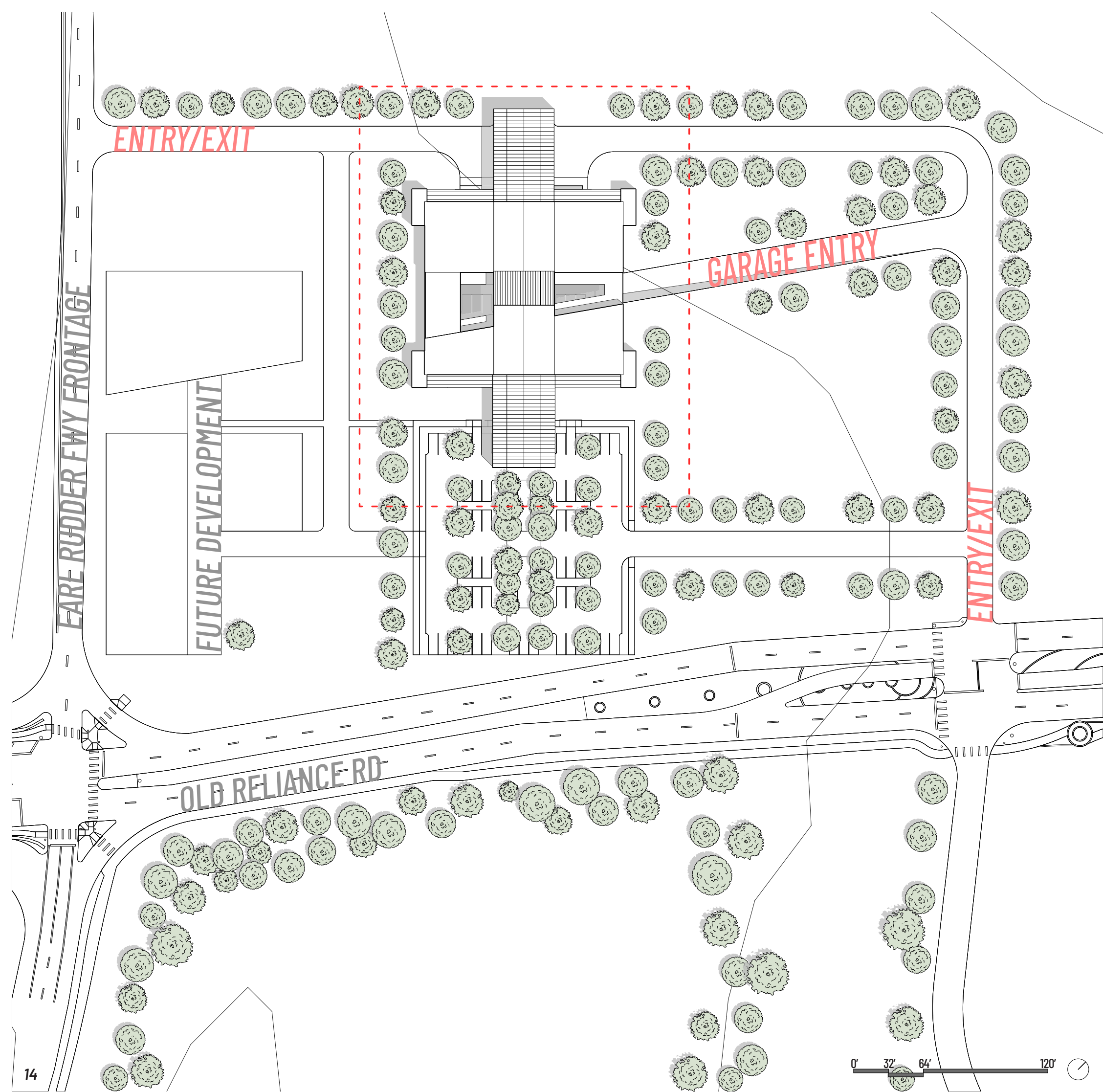

PROGRAM + PARTI

Two central spaces in the program are the classroom and workshop spaces. Student-dedicated spaces that make being at the school more pleasant and focused on academic success were added. An area of the building that has study spaces, a breakroom and workroom gives students a space to gather between classes and meet new people, as well as a quiet space to study or complete other work.

Keeping class sizes small – roughly 16 students per instructor – allows for more individualized instruction and can give students more frequent feedback on their skills (Schloss, 2023). The class size was the driver for determining the size of the classrooms, but the size of the workshops are larger to accommodate equipment and to ensure that each student has their own welding booth. The project includes a dedicated material processing space with an overhead crane and welding gas storage, and a weld testing area that allows students to test the integrity and quality of their welds in a controlled manner with special equipment.

A goal was to facilitate a partnership with a nearby high school welding program by including space for a junior-level program that combines welding with other activities that are manufacturing-oriented. An additional space was dedicated to smaller scale projects such as 3D printing and laser cutting for students who may not be enrolled in a welding program. A large gallery/lobby space was included, as well as a commons space with a small café counter and reception desk. Staff areas such as offices, a workroom, conference room and breakroom facilitate the operations of the school.

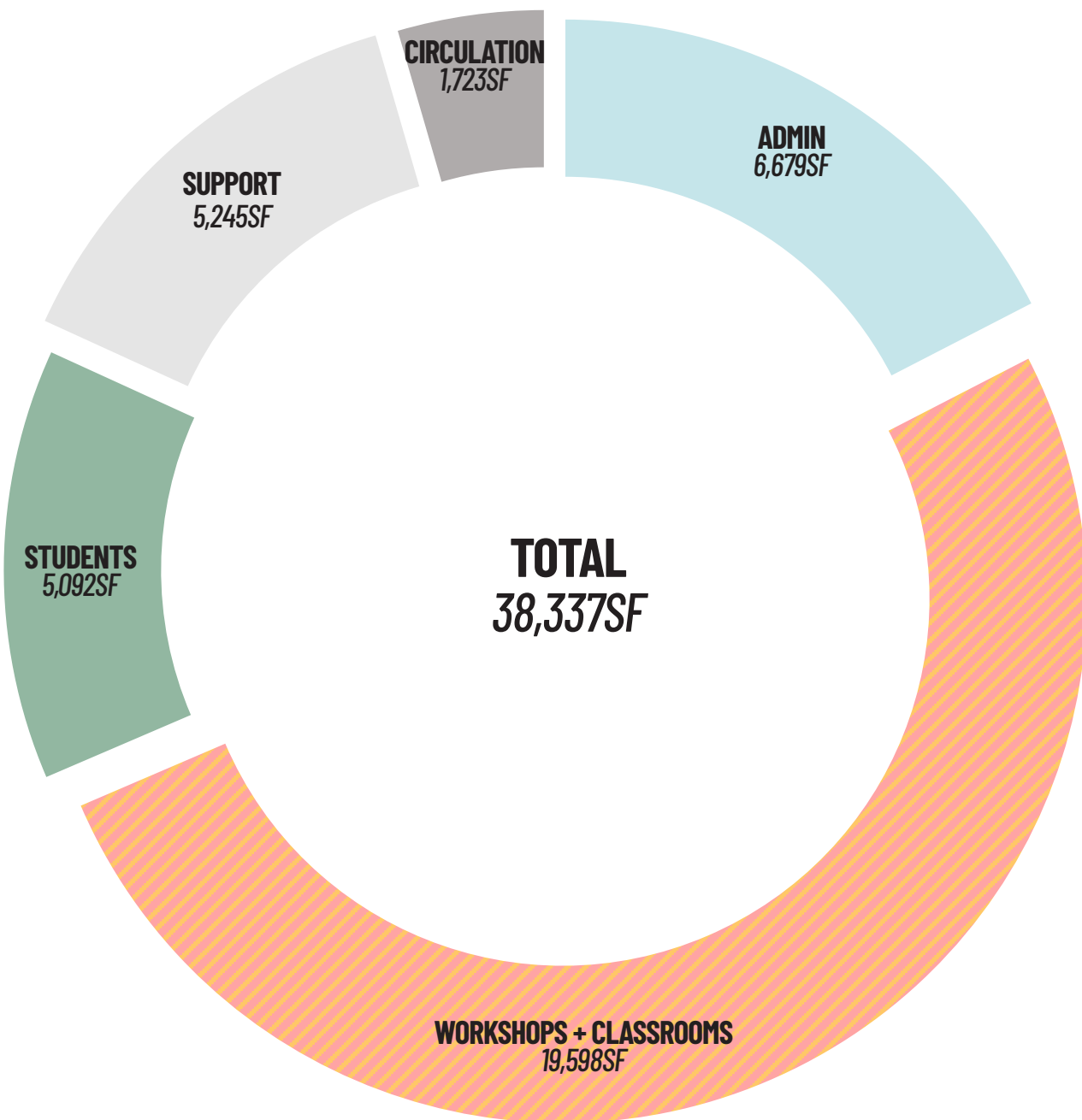

The building's spaces arrange themselves within a 32' grid with several 12' bays, creating an organizational language that sorts the many served and service spaces in the building. A large wedge is subtracted from the center, with the wedge shape based on deviations from the standard grid. This centralizes circulation while providing natural light to the interior spaces. This subtraction also provides ventilation to the workshop spaces and eliminates large, conditioned hallways.

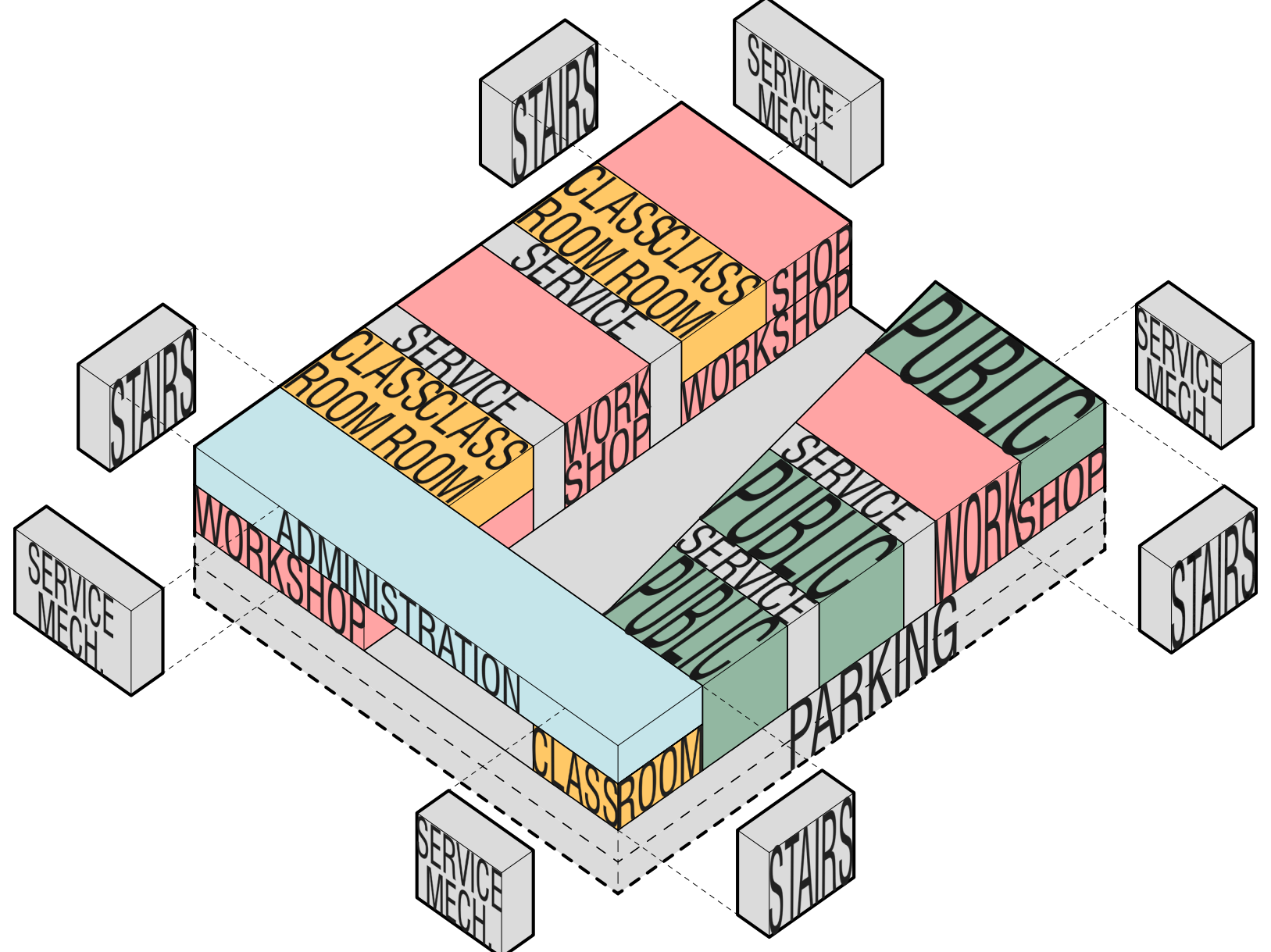
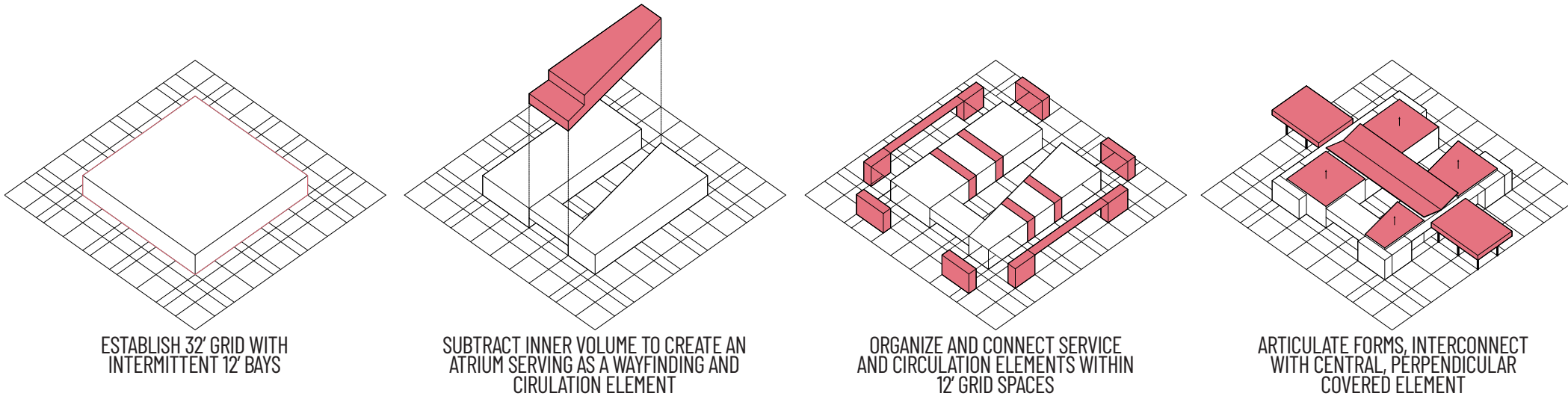
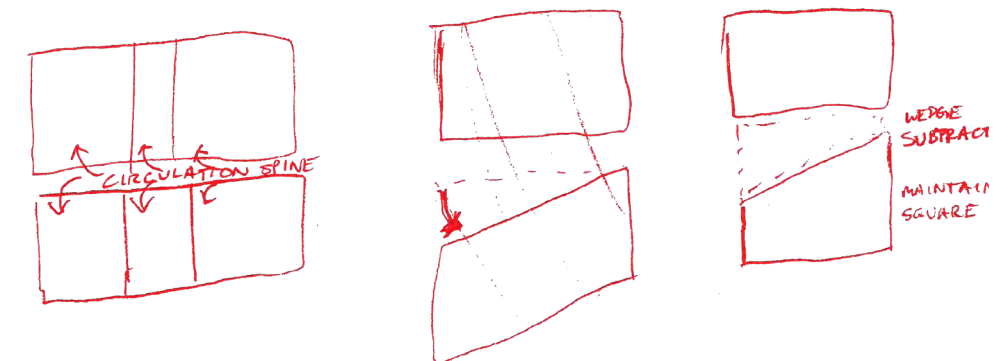

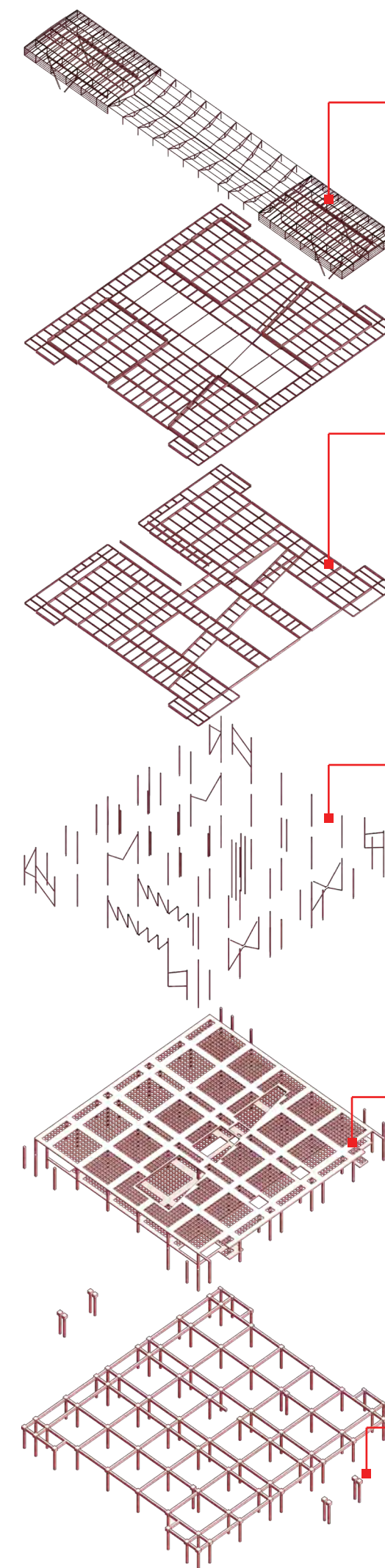
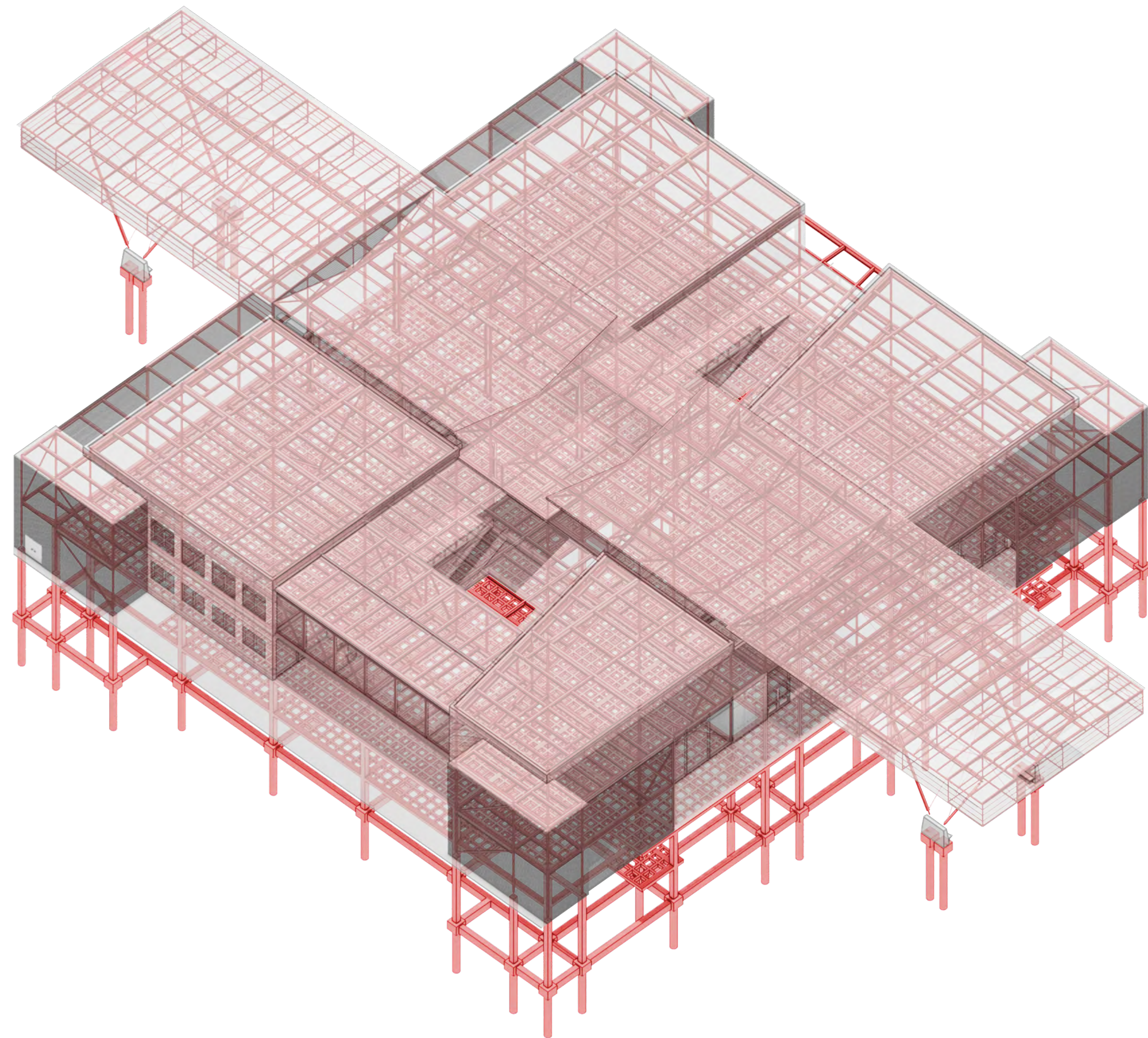

Steel supports two roofs, with a main roof covering the main masses and a secondary roof element that crosses over the top of the building, perpendicular to the atrium. This secondary roof is much lighter, constructed of tube steel trusses and stiffened with steel cables.

The second level is supported with steel framing, with welded connections used in locations with exposed structure. The choice for steel was easy, given the school's primary focus on training new welders. A core goal of the project is to express the structure wherever possible, creating moments that highlight various weld types and exhibit their uses and assembly methods.

There are several unique moments in the otherwise regular steel structure. A 60' truss supports part of the administration and spans over the atrium, and wind bracing elements on the front face of the building remain prominently exposed. These unique elements further tie into the goal of utilizing the building as a teaching element in the welding training process.

At the ground plane, the structural material switches from steel to concrete. Supporting the first level is a concrete pan joist system, with the lower level of the pan joist system supporting the upper level of parking. A lower level of parking sits below.

A network of concrete piers and grade beams collects the loads from the steel and parking above. Resting directly on the grade beams is the lower parking level.

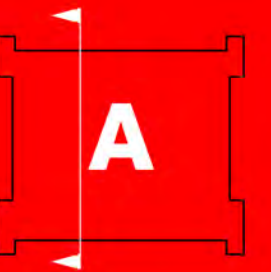
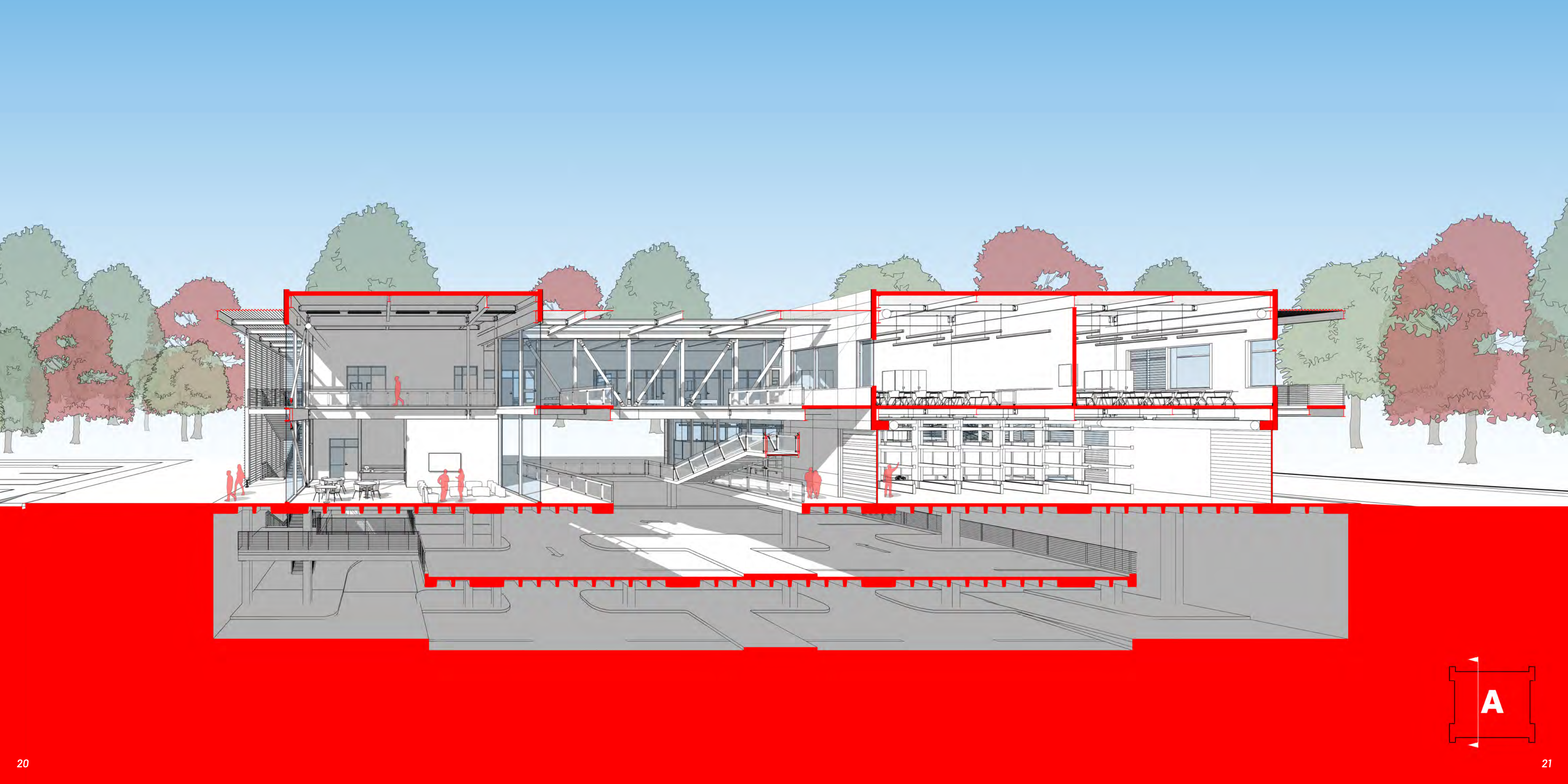

3

COHESION

LEVEL 1

The ground level contains many of the building's main functions, with welding shops occupying the north half of the building and public areas to the south, such as the lobby and commons space. Announcing each of the main entry points to the building are two large canopies, providing covered drop-off spaces for visitors and deliveries. An organizing grid of 32' with intermittent 12' bays sets up the building's spatial layout. The grid is evident throughout the building and helps to sort the building's many unique functions. This develops further with the 12' bays delineating service spaces and 32' bays acting as main functional areas of the school, such as classrooms and workshops. A central atrium deviates from the regular rhythm of the grid, forming a wedge-shaped open space in the heart of the building. The atrium acts primarily as a wayfinding element, with additional benefits including natural ventilation of the parking garage below and sunlight to the interiors of the building. Two large shops comprise the majority of the ground level, with space for 16 students each and a space for assembling large projects. A manufacturing shop on the front of the building engages high school CTE programs with the welding trade by providing a space for classes and equipment. Other functions include a weld test lab and a space for processing and storing materials.

- DELIVERY → PROCESS
STORAGE → WELD
- WELDING → GAS STORAGE → PROCESS + STORAGE → TOOLS → WELDING
- 1 LOBBY+GALLERY
 - 2 MENS RR
 - 2' WOMENS RR
 - 3 MOTHERS ROOM
 - 4 MATERIAL STORAGE
 - 5 MANUFACTURING SHOP
 - 6 TOOL STORAGE
 - 7 ELECTRICAL
 - 8 FIRE RISER
 - 9 WELDING SHOP
 - 10 PROJECT ASSEMBLY/STORAGE
 - 11 MATERIAL PROCESSING
 - 12 WELD TESTING LAB
 - 13 SHIPPING+RECEIVING
 - 14 RESTROOM
 - 15 AIR COMPRESSOR
 - 16 GAS STORAGE
 - 17 MEDIA+MULTIPURPOSE
 - 18 EQUIPMENT STORAGE
 - 19 IT+MDF
 - 20 COMMONS
 - 21 CAFE PREP/STORAGE
 - 22 CUSTODIAN

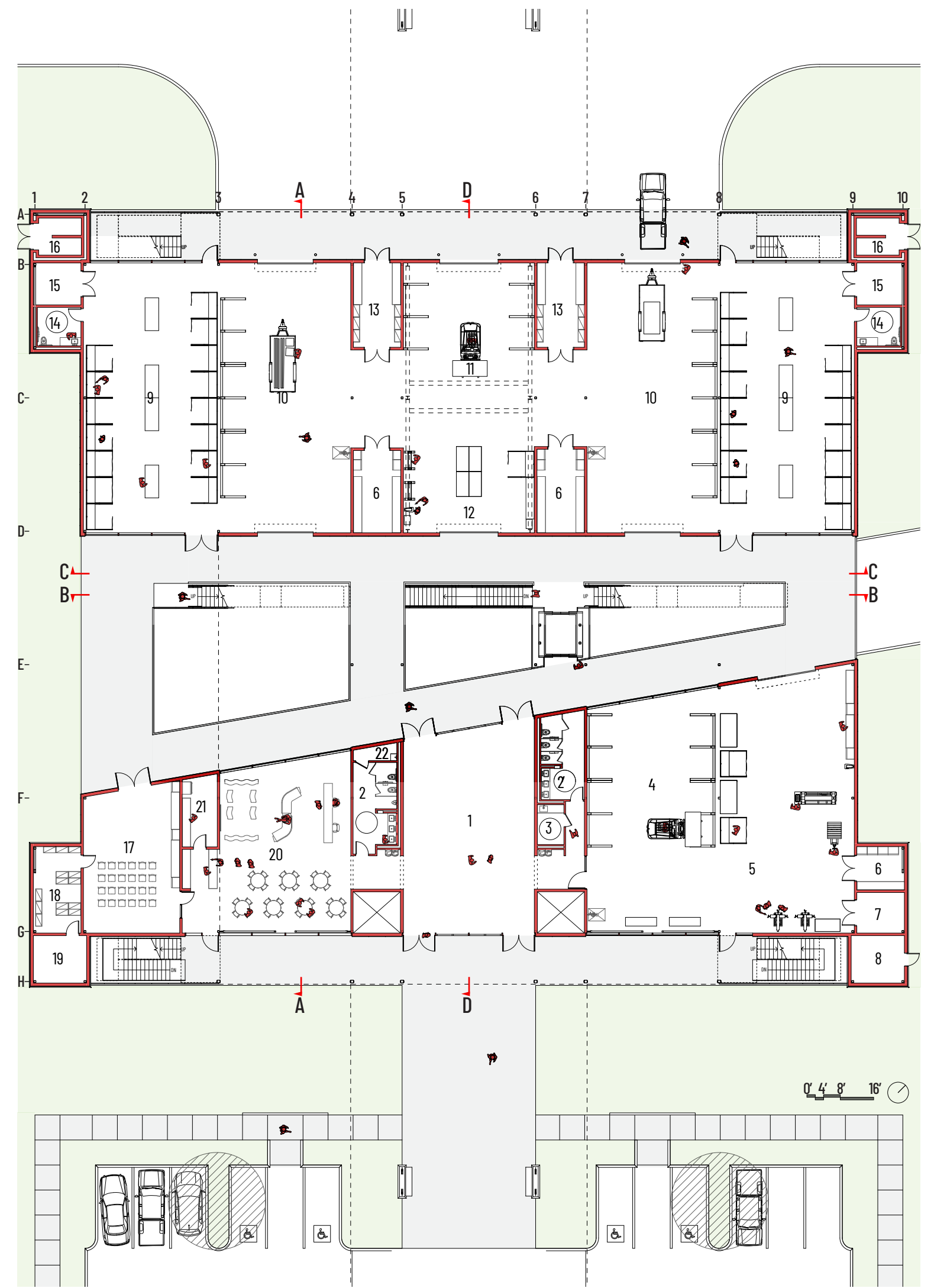

SECTION

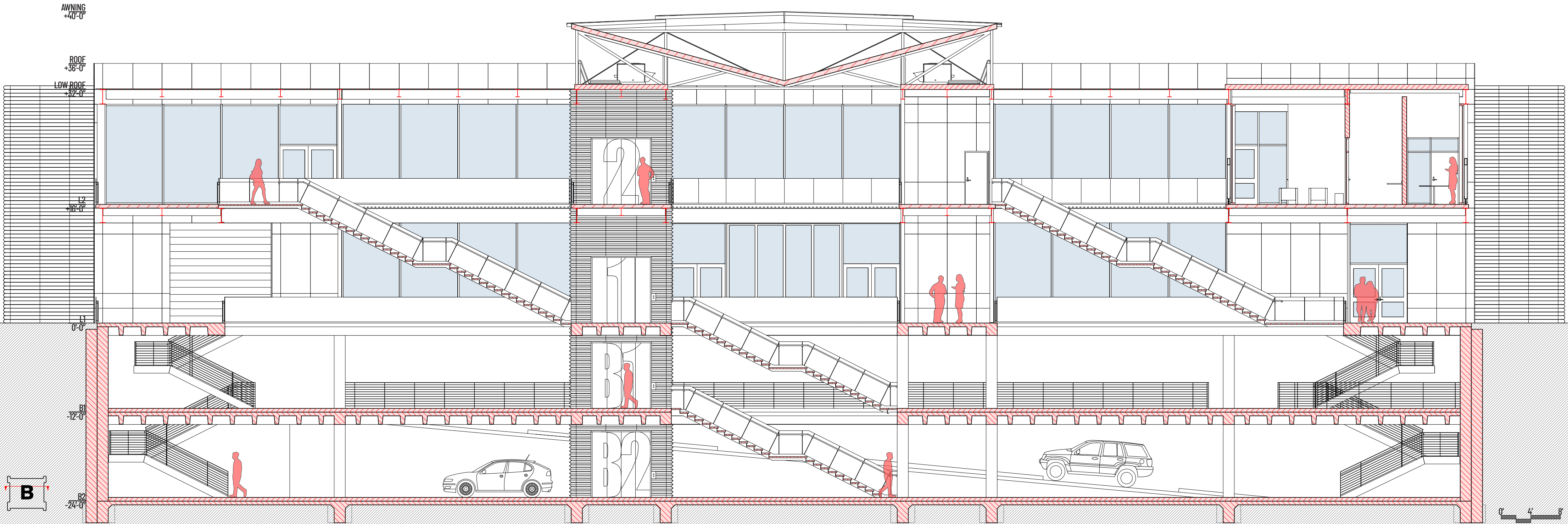

B

0 4 8

NEXT LEVEL

The freight elevator is a prominent element in the building, vertically intersecting the otherwise uniform atrium. The bright red metal panel housing relates to other circulation elements in the project. As well as serving in its intended capacity as a heavy equipment lift, the elevator serves a dual function as a passenger elevator, capable of comfortably fitting over a dozen passengers. Its location also serves as an important wayfinding element and fits neatly into one of the 12' service bays. Its machine room-less design allows it to fit efficiently in such a narrow space, and a pit sits below the bottom level for maintenance access as needed. The perforated metal seen on the elevator shaft and exterior stairs is panelized 4'x8' sheets, with attachment points on each repeated 6" triangular module of the sheet. These connect to small 4" T angles that run the full height of each floor and connect to the primary structure of the building. At the ends, 8" corner panels attach to the T angles as well as to the straight panels with small tabs. The perforated panels allow airflow for passive ventilation.

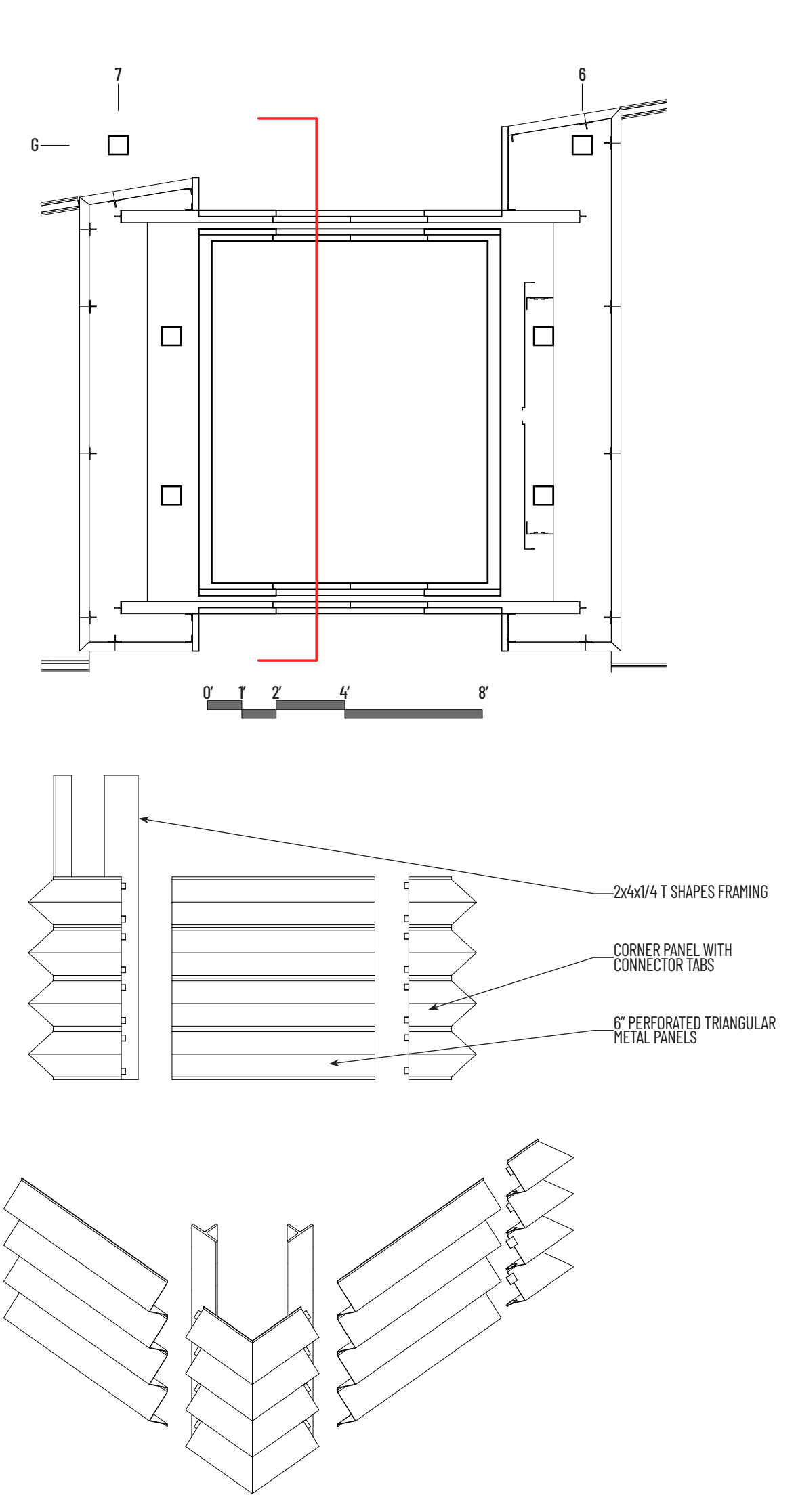
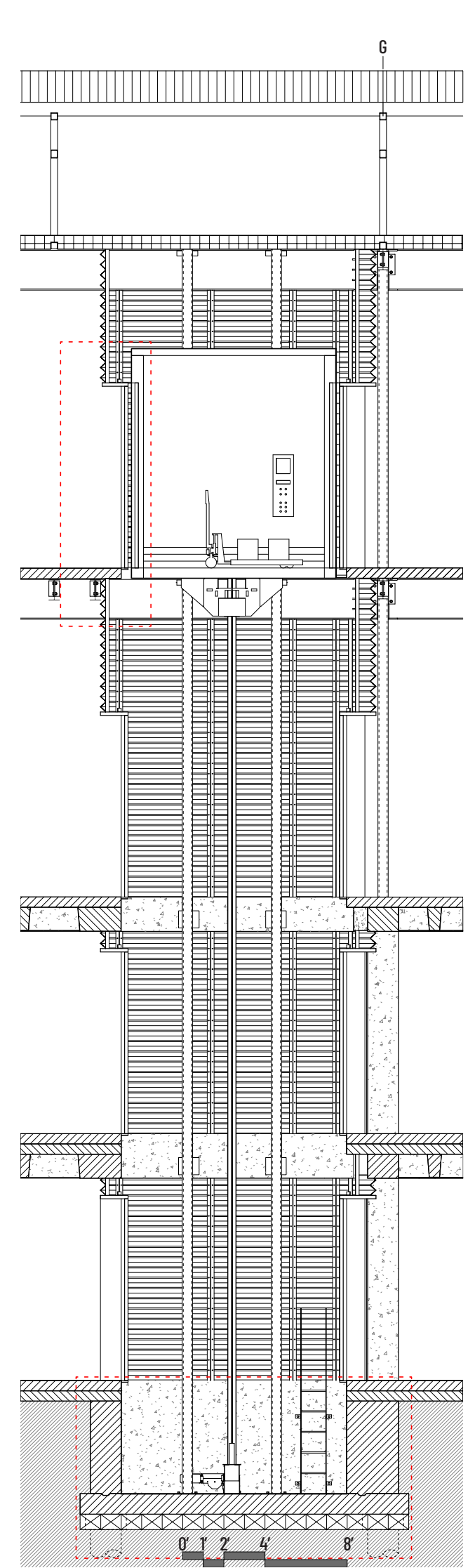

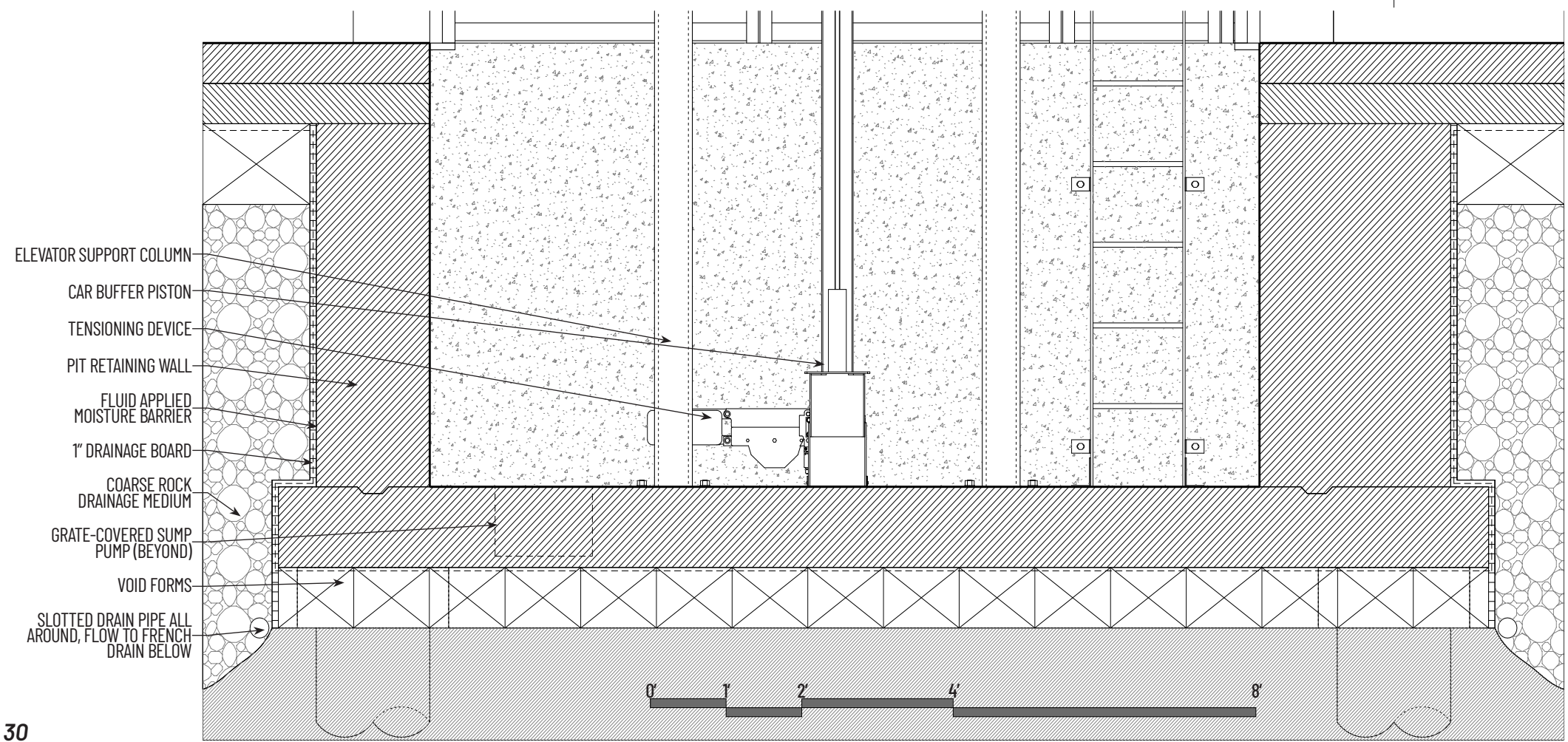
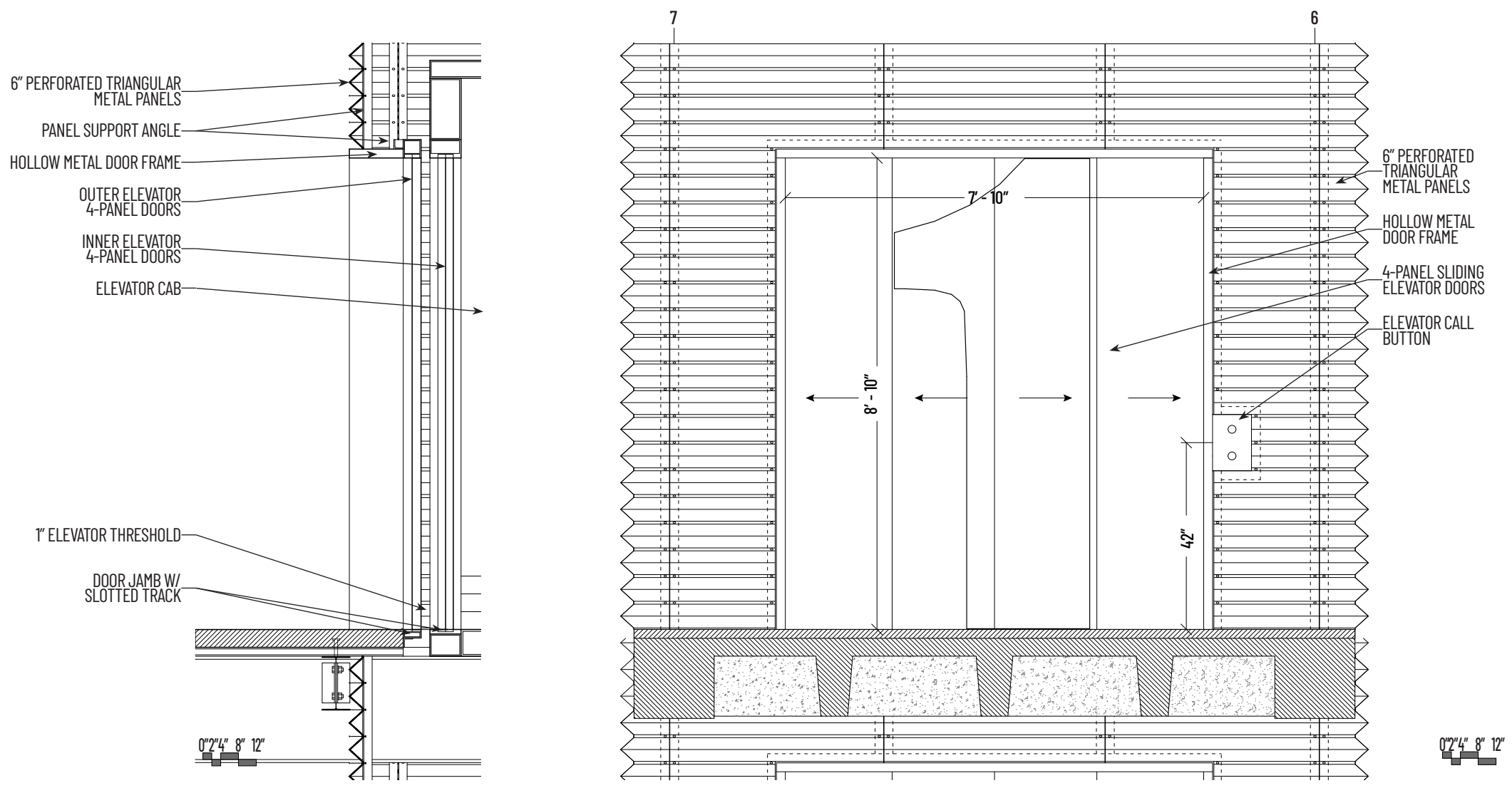

UP+ DOWN

Main stairs connect each floor through the atrium space. These stairs share a variety of features and elements seen elsewhere in the building, along with the distinctive red on the glass side panels. Circulation elements share this red color, which acts as a wayfinding tool. The stairs achieve an impressive span of over 40', made possible by using lightweight HSS tubes welded together with intermediate verticals for rigidity. The stringer trusses that are created as a result are largely see-through, and are further strengthened by an array of fritted glass panels bolted on both faces. One of the goals of the project was to utilize common elements in new/innovative ways, with elements such as the stair treads, stringers and risers built from typical steel components that can be sourced or made easily.

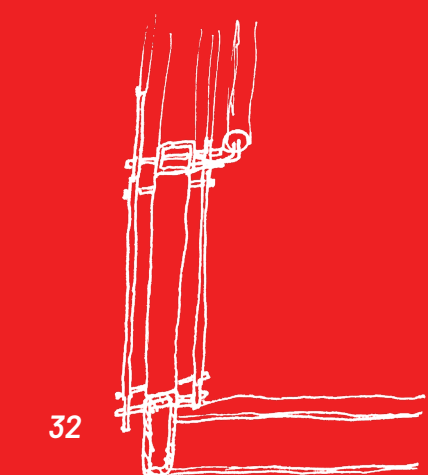
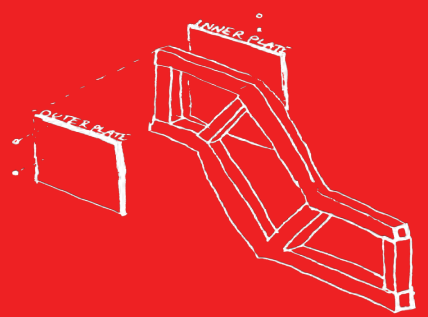
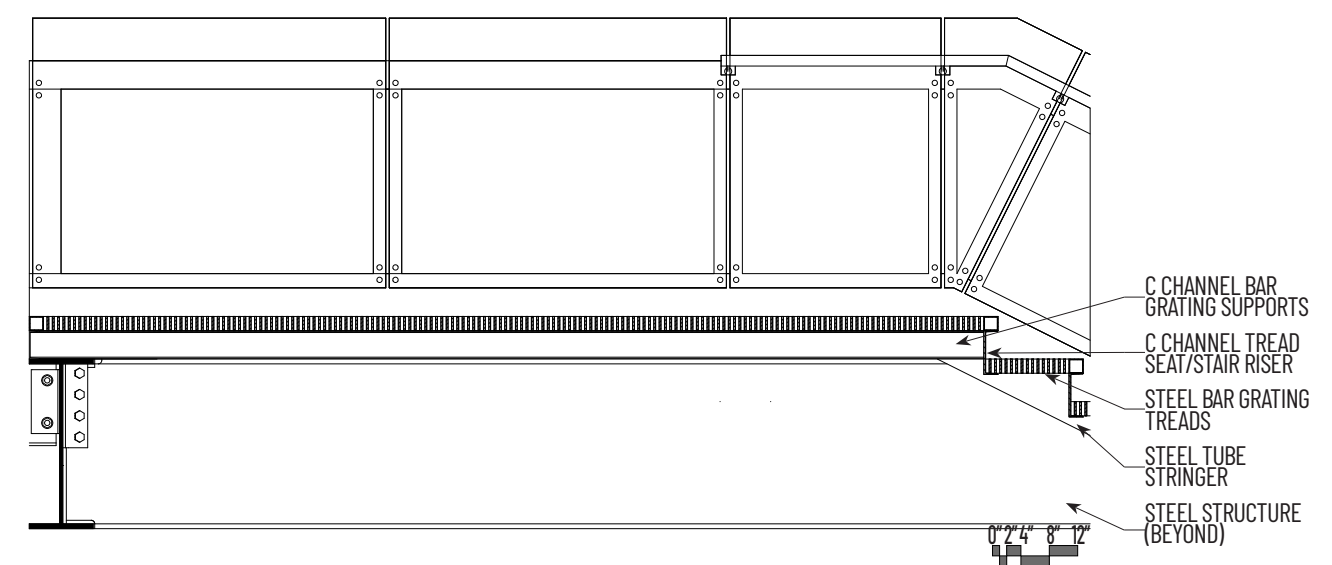
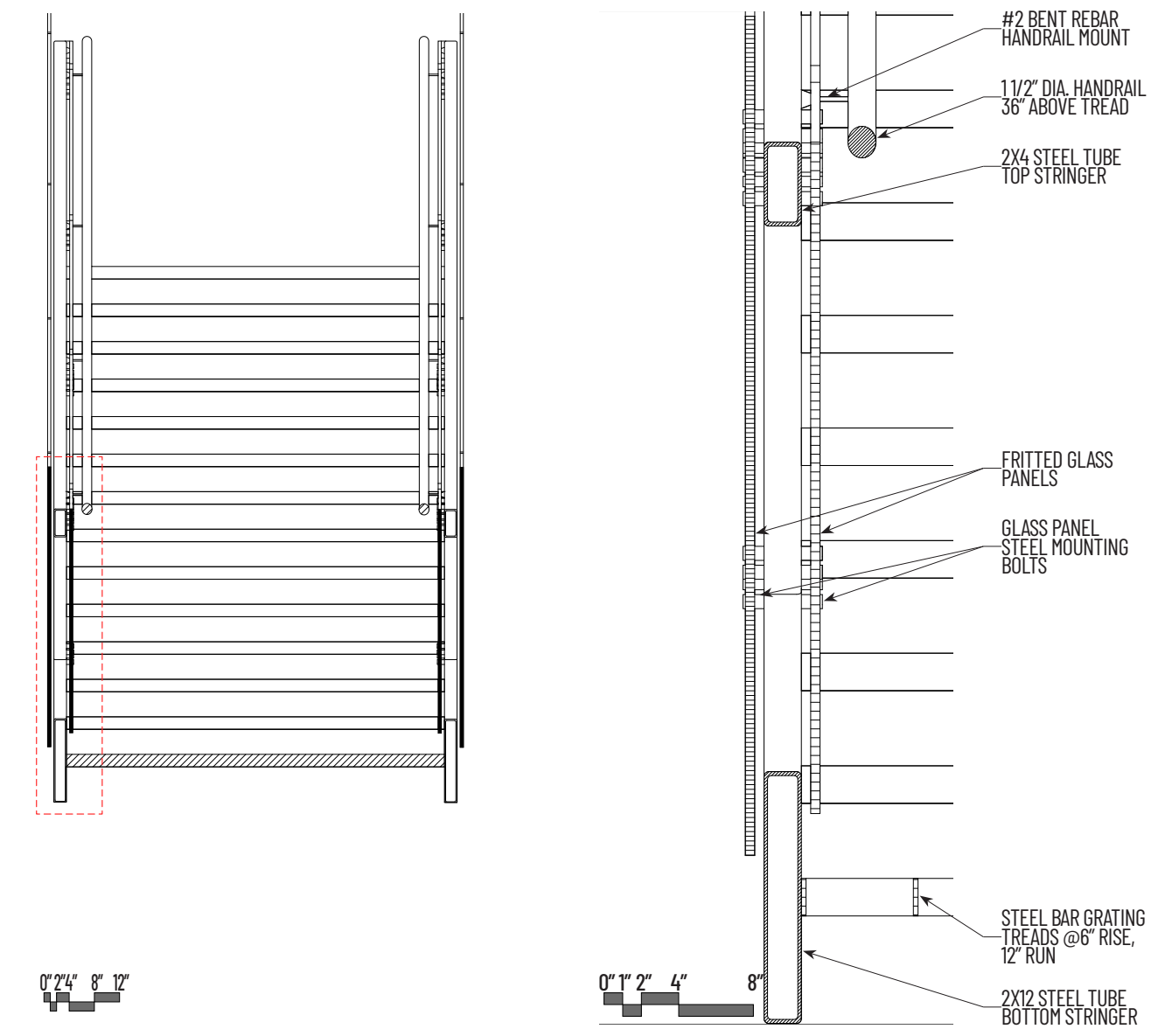
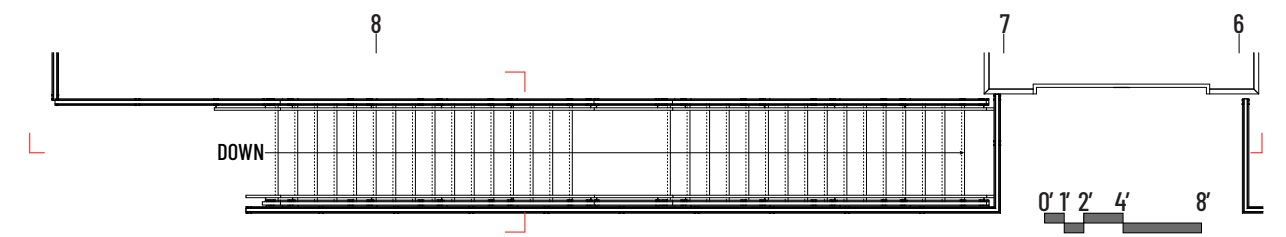
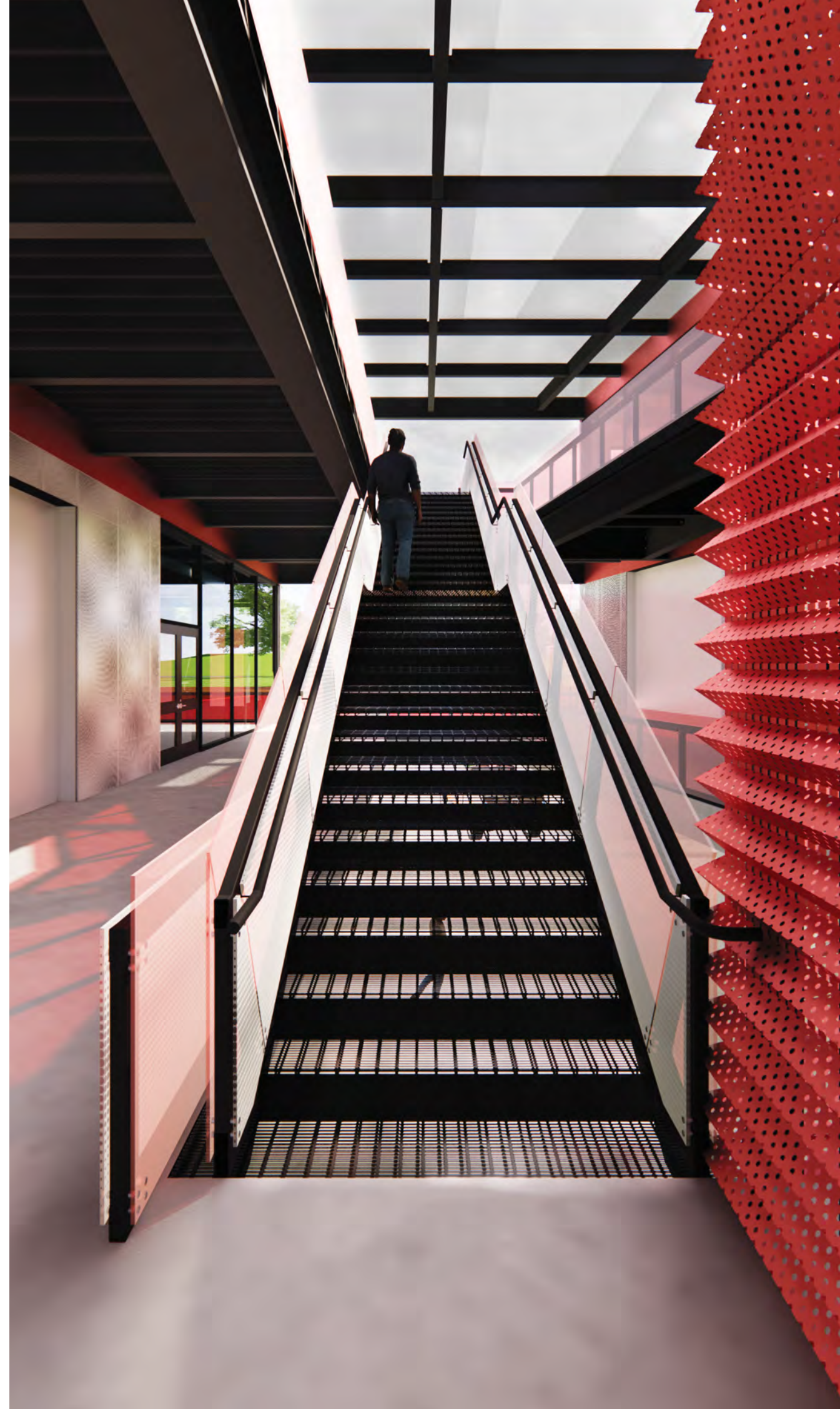

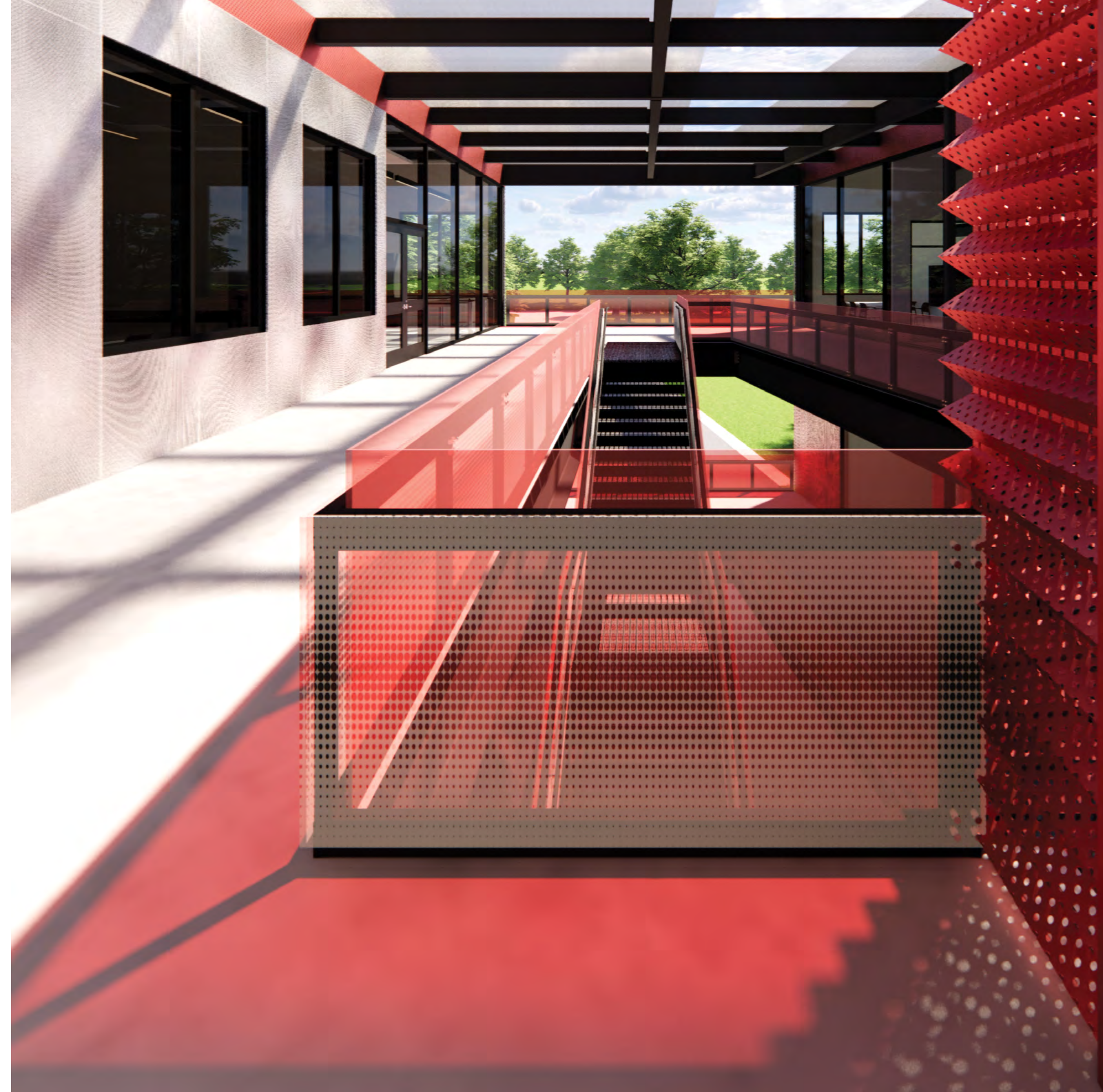
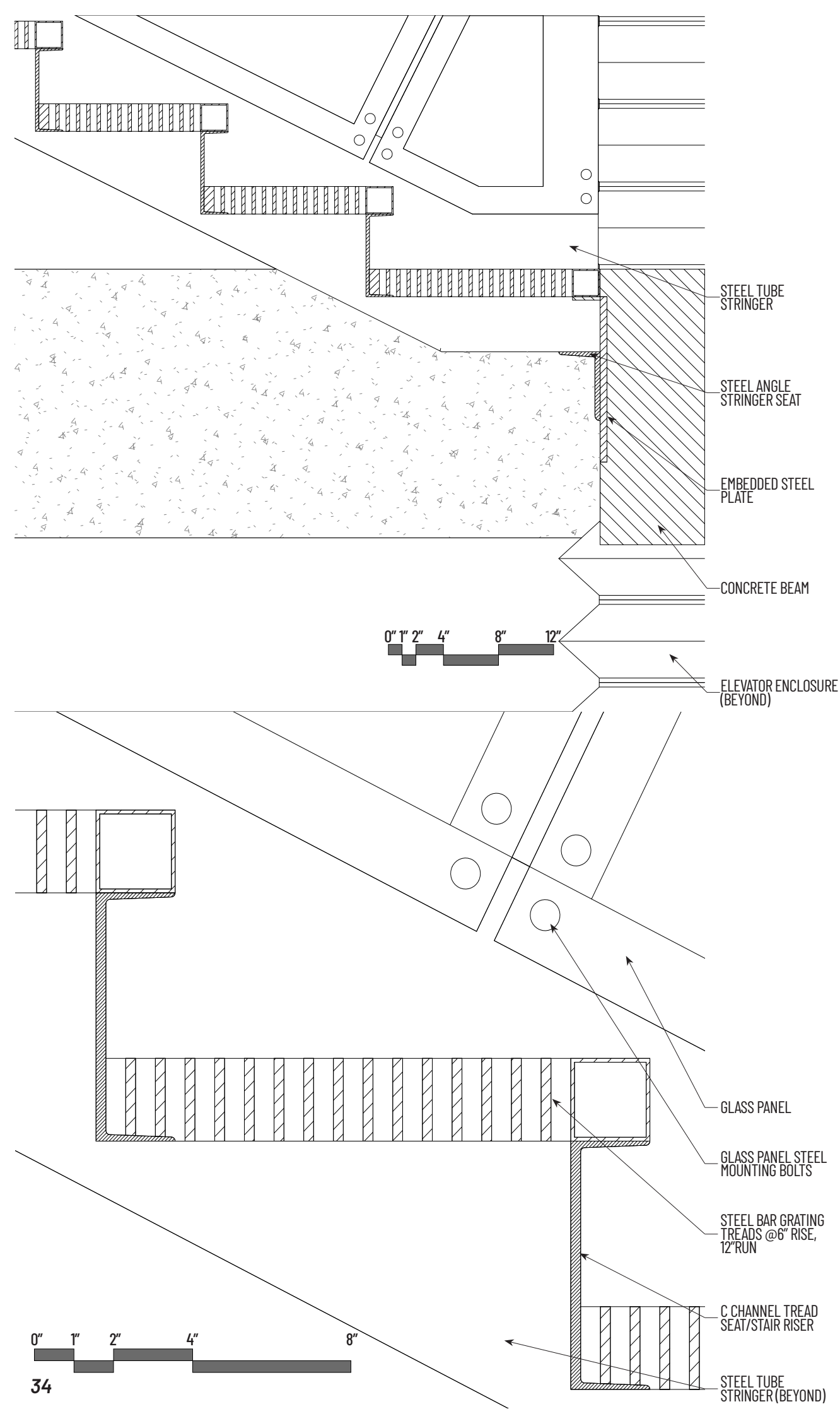



LEVEL 2

The second level features three prominent double-height spaces at the front of the building, adding volume to the commons, lobby and manufacturing shop, as well as introducing additional sunlight to those spaces. The school contains four classrooms, with space for 16 students and enough room to rearrange the spaces for demonstrations, group activities and small-scale projects. Along the entire west side of the building are the administrative functions for the school. This includes offices for the administration and instructors, as well as a variety of meeting spaces, a break room and even a career center to connect students with jobs in the welding field. A maker space is housed on the second floor, serving a similar role as the manufacturing shop below for high school welders and more experienced welders and fabricators to collaborate and share resources. The maker space has work zones for small projects, along with laser cutting and 3D printing capabilities. It was important to dedicate a space for students to use in their time between classes. A study lounge is provided for students to make private calls, work in study rooms, and provides a place to store and eat their lunches during the day. There are also copiers and vending machines, as well as a private restroom.

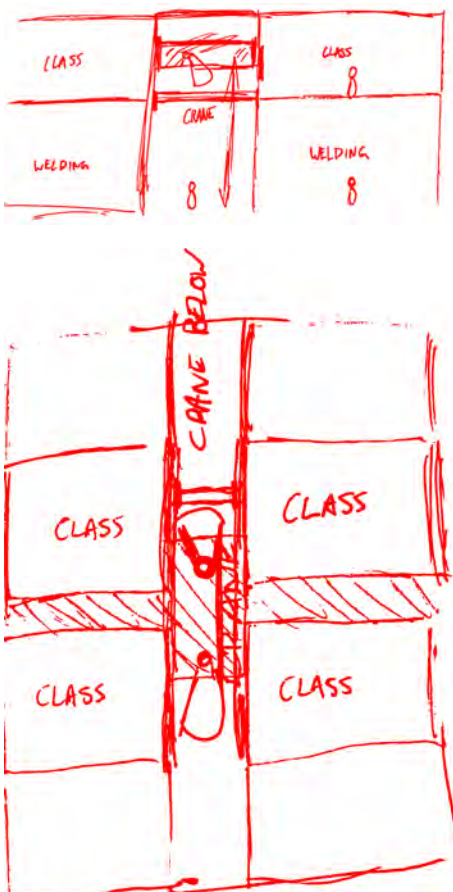

- 1 MENS RR
- 2 WOMENS RR
- 2' MOTHERS ROOM
- 3 STUDY LOUNGE
- 4 STUDY ROOM
- 5 WORKROOM
- 6 PRIVATE CALL
- 7 BREAKROOM
- 8 RESTROOM
- 9 CUSTODIAN
- 10 ELECTRICAL/IDF
- 11 MECH/ROOF ACCESS
- 12 MAKER SPACE
- 13 LASER CUT ROOM
- 14 WELDING CLASSROOM
- 15 STORAGE
- 16 MECH. ACCESS
- 17 IT/IDF
- 18 OFFICE
- 19 HUDDLE SPACE
- 20 CAREER CENTER
- 21 CONFERENCE ROOM
- 22 BUSINESS OFFICE
- 23 ADMIN/WAITING/FLEX



SOUTH SIDE

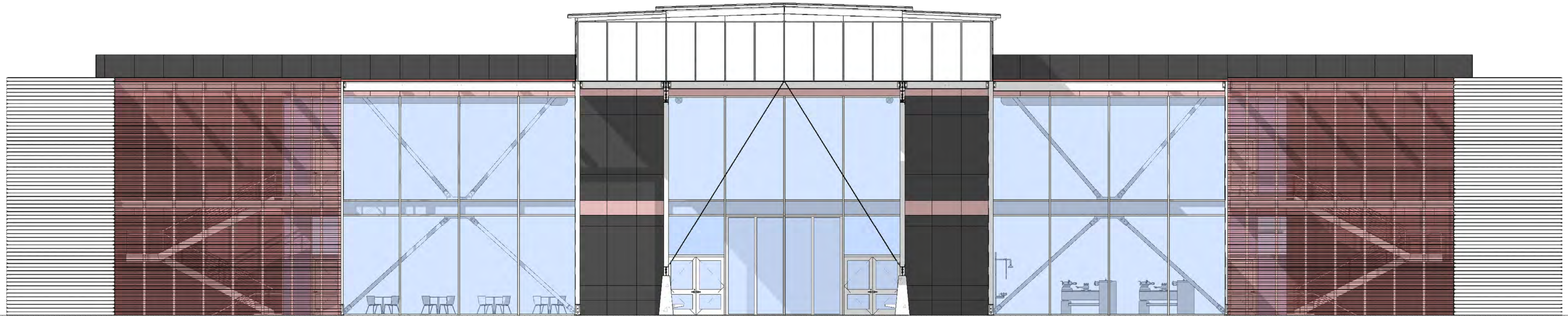

AWNING
+40'-0"

ROOF
+36'-0"
LOW ROOF
+32'-0"

L2
+16'-0"

L1
0'-0"

B1
-12'-0"

B2
-24'-0"

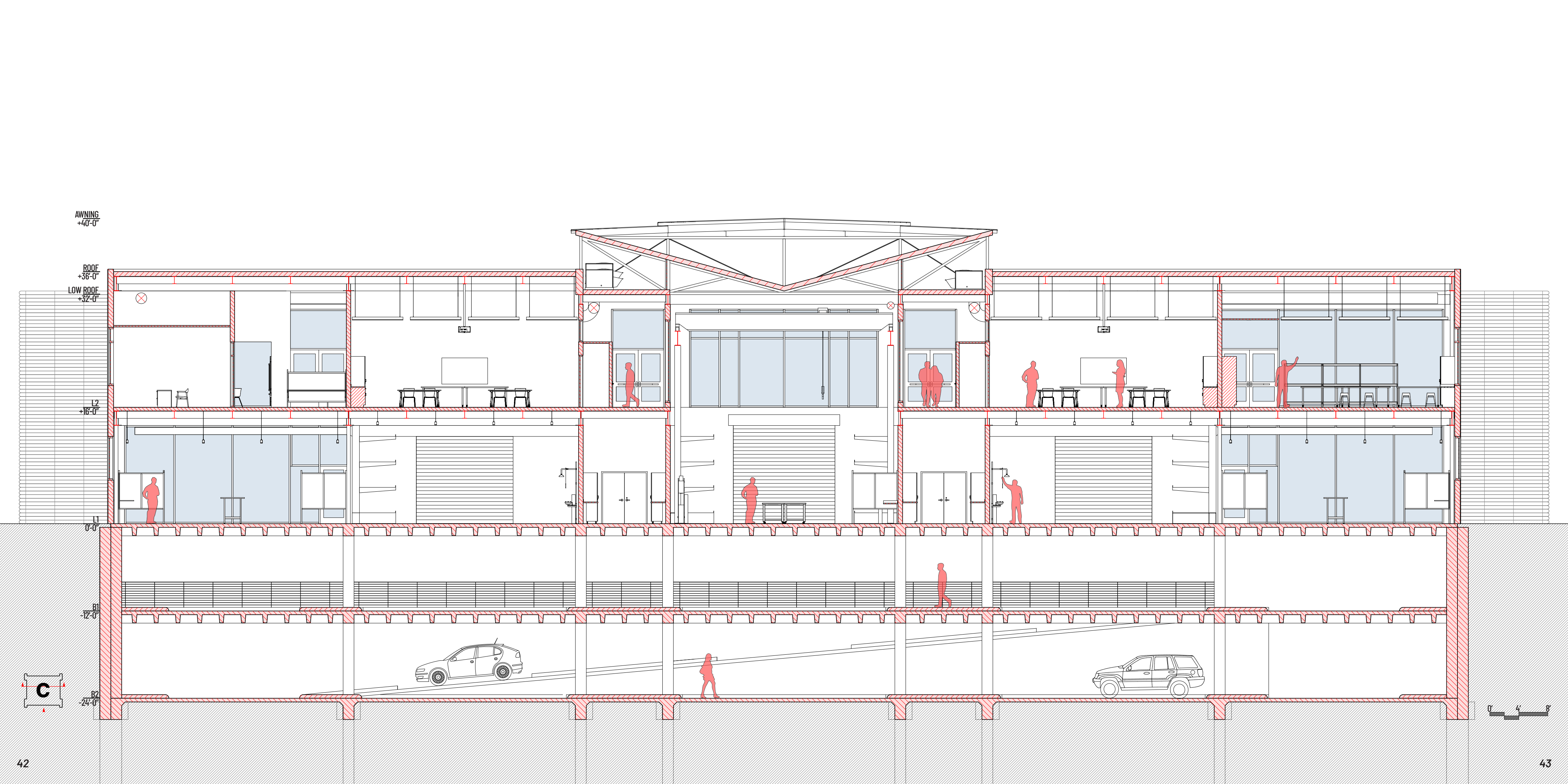
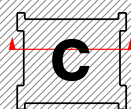



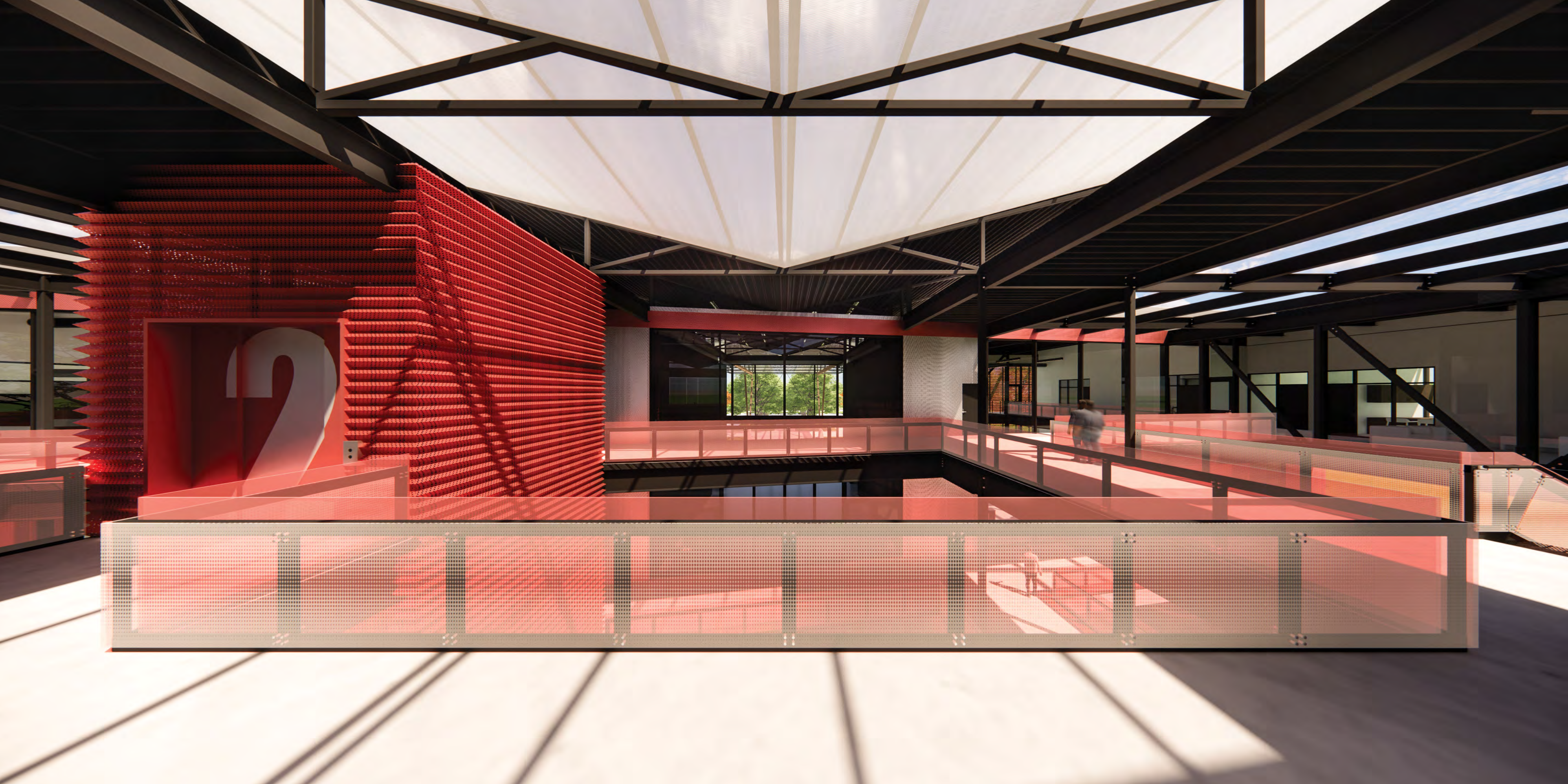



3:00
Monday, March 4

3:00
Monday, March 4

B1

Serving as a supplement to the surface parking, two levels of parking are tucked beneath the footprint of the building. Everything below the ground plane is constructed from concrete, and serves as a sturdy foundation for the steel above. Drivers enter from

a ramp that accesses the upper level of the garage, and a one-way loop within each parking level circulates traffic. Between floors, two one-way ramps guide traffic in dedicated up and down directions. There are approximately 90 underground spots

that would otherwise increase the paved area of the site. This also gives more opportunities for future developments. This arrangement presented unique design challenges and opportunities that both reinforced the structural grid's presence in the

building, as well as dictating where vertical circulation elements could feasibly be placed.

B2

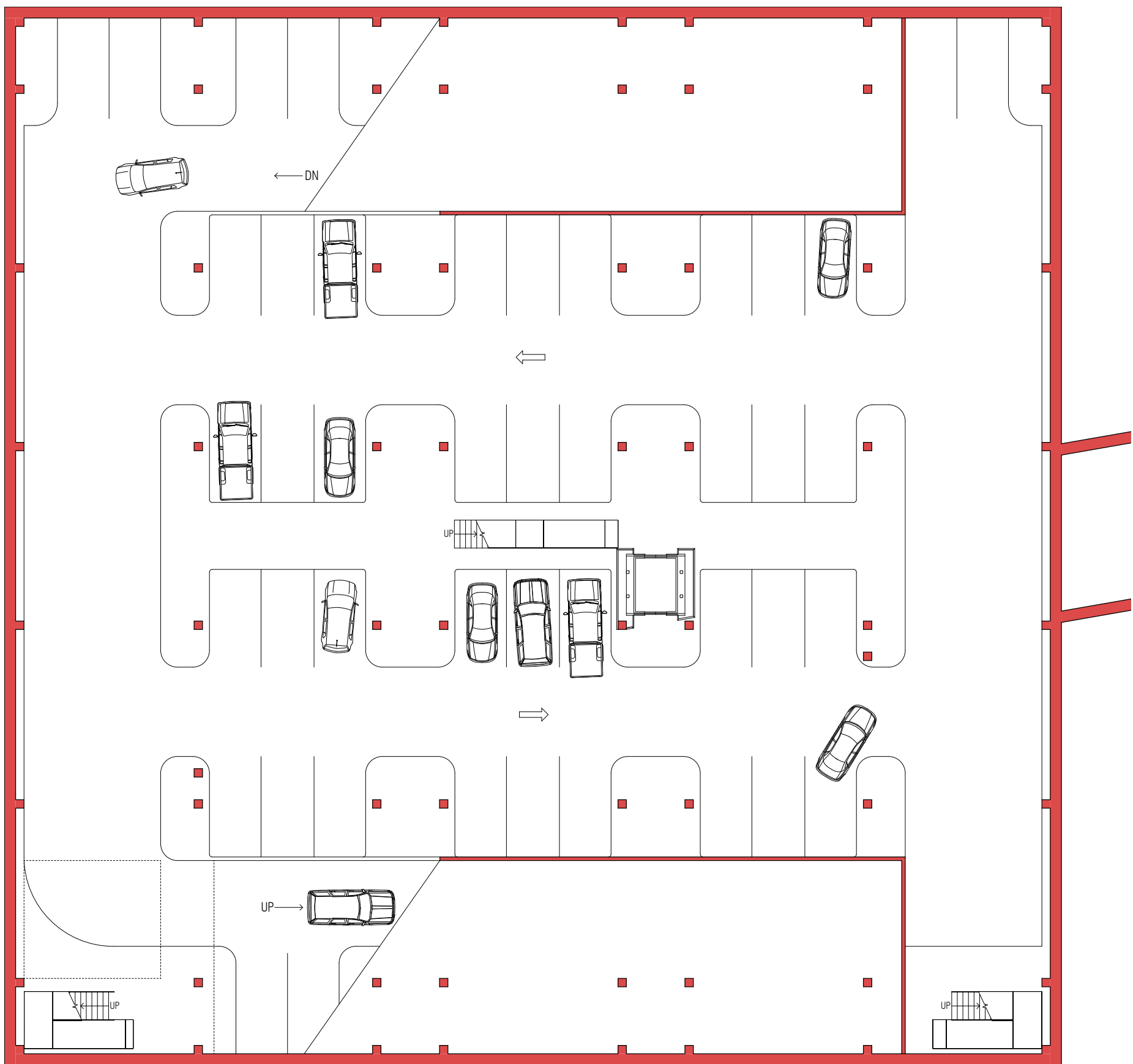
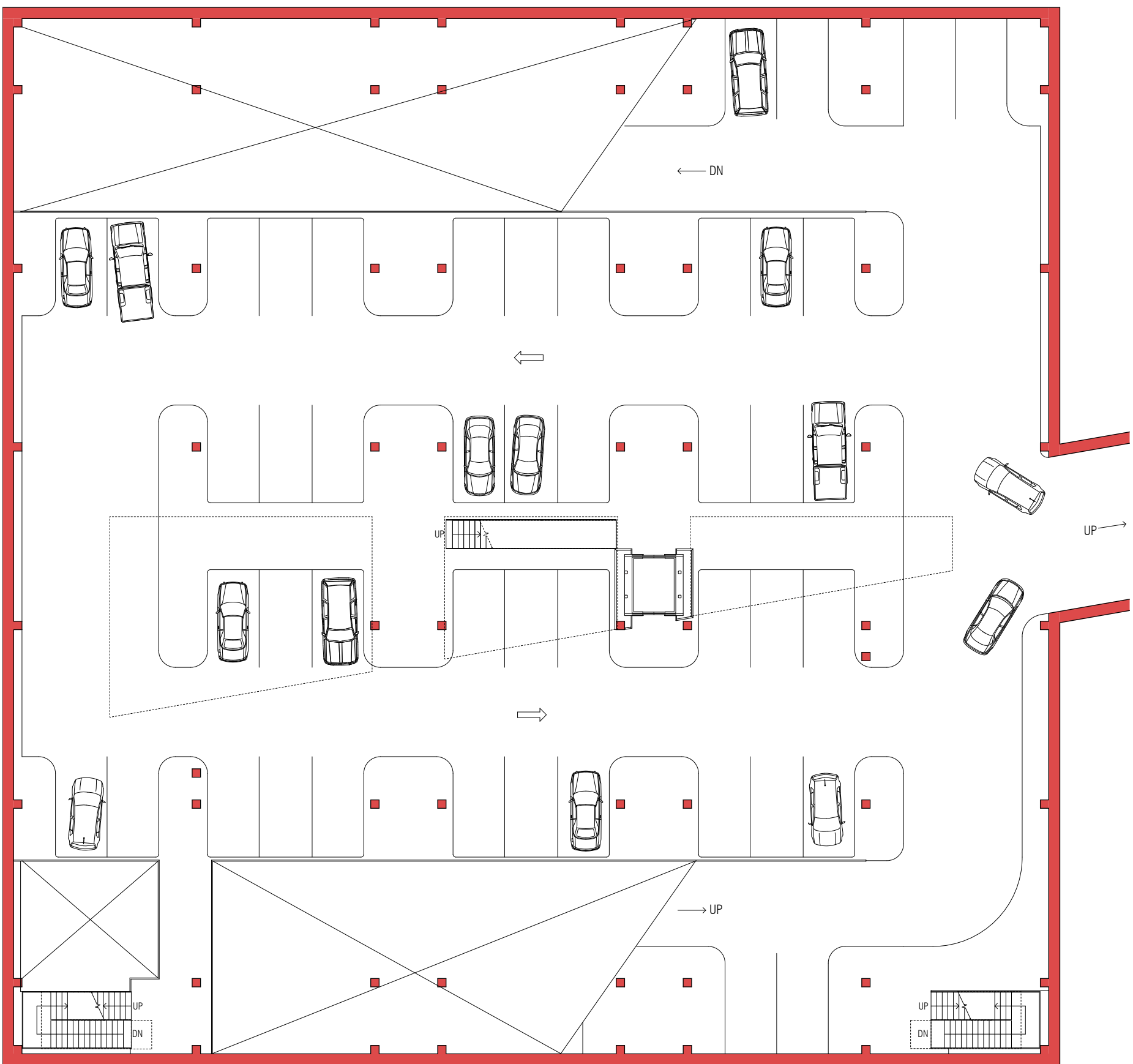

EAST SIDE

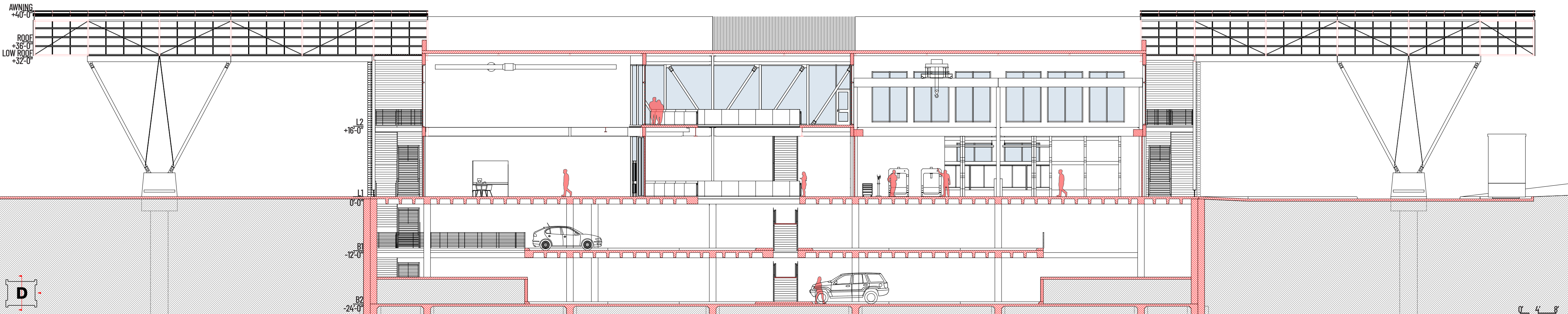
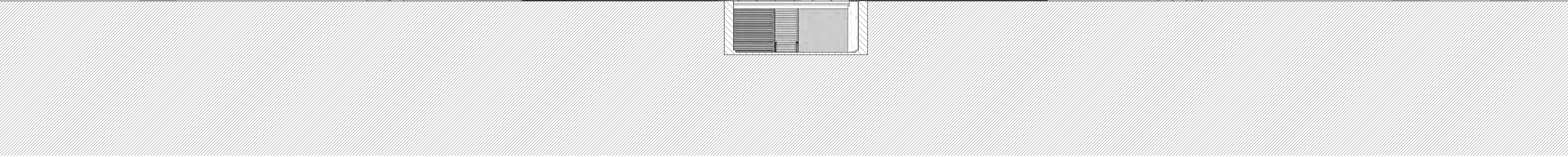



AXIAL SHADE

Marking the two main entry points and capping the perpendicular axis of the building are two identical awnings. The south awning highlights the lobby entrance for visitors and provides coverage from rain for drop-offs. The north awning serves as protection for the loading zone adjacent to the material processing space to allow deliveries to be staged and loaded outside. Made from small HSS tubes welded into trusses and stabilized with steel tension cables, the awnings have a refined, lightweight physical presence. Perforated metal panels similar to those used on the building surround the sides of the awnings, and polycarbonate panels serve as a translucent roof that filters sunlight into the covered drop-off areas. The awnings meet the ground at only two main points, supported by a concrete base that doubles as a bench for sitting.

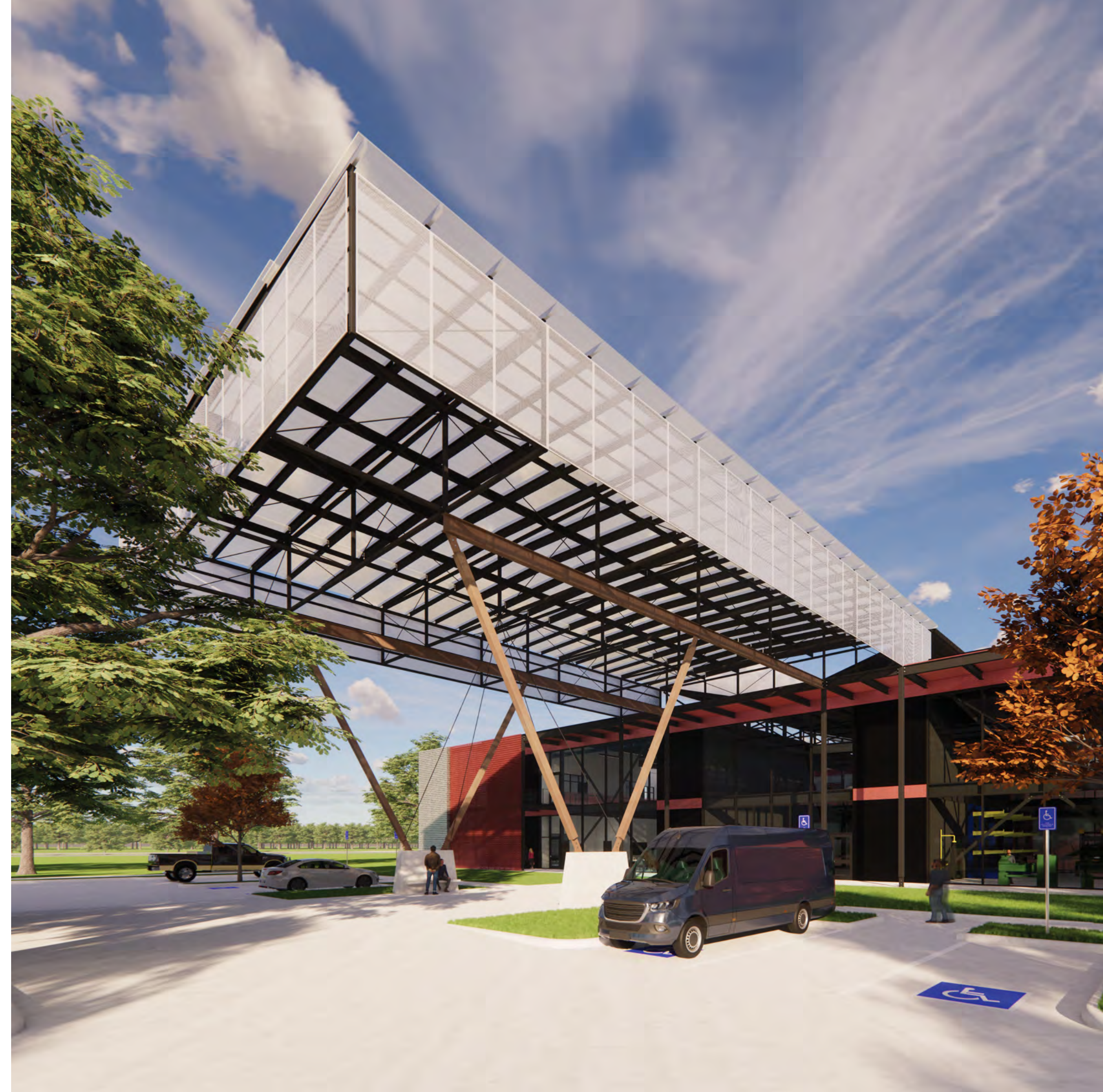
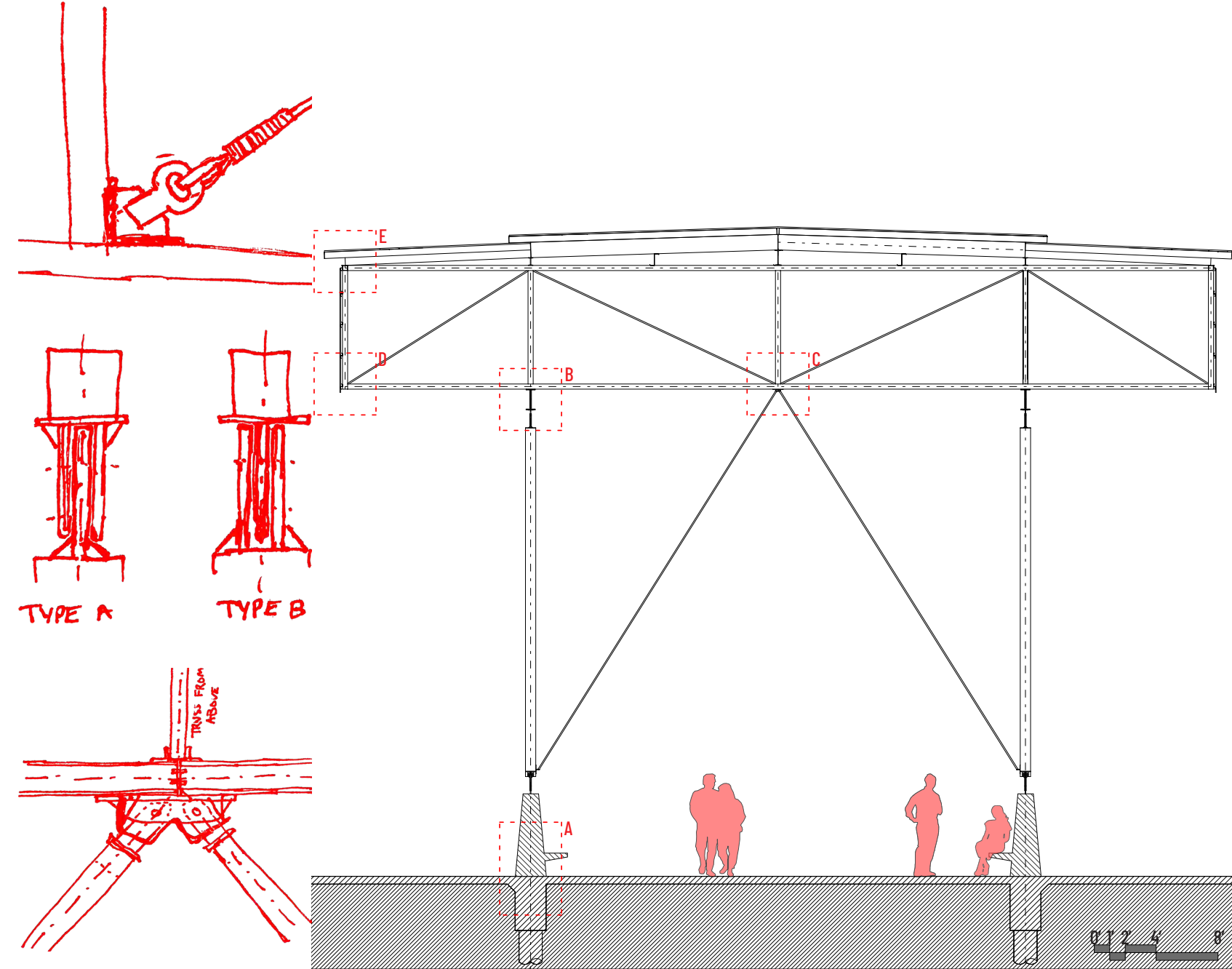
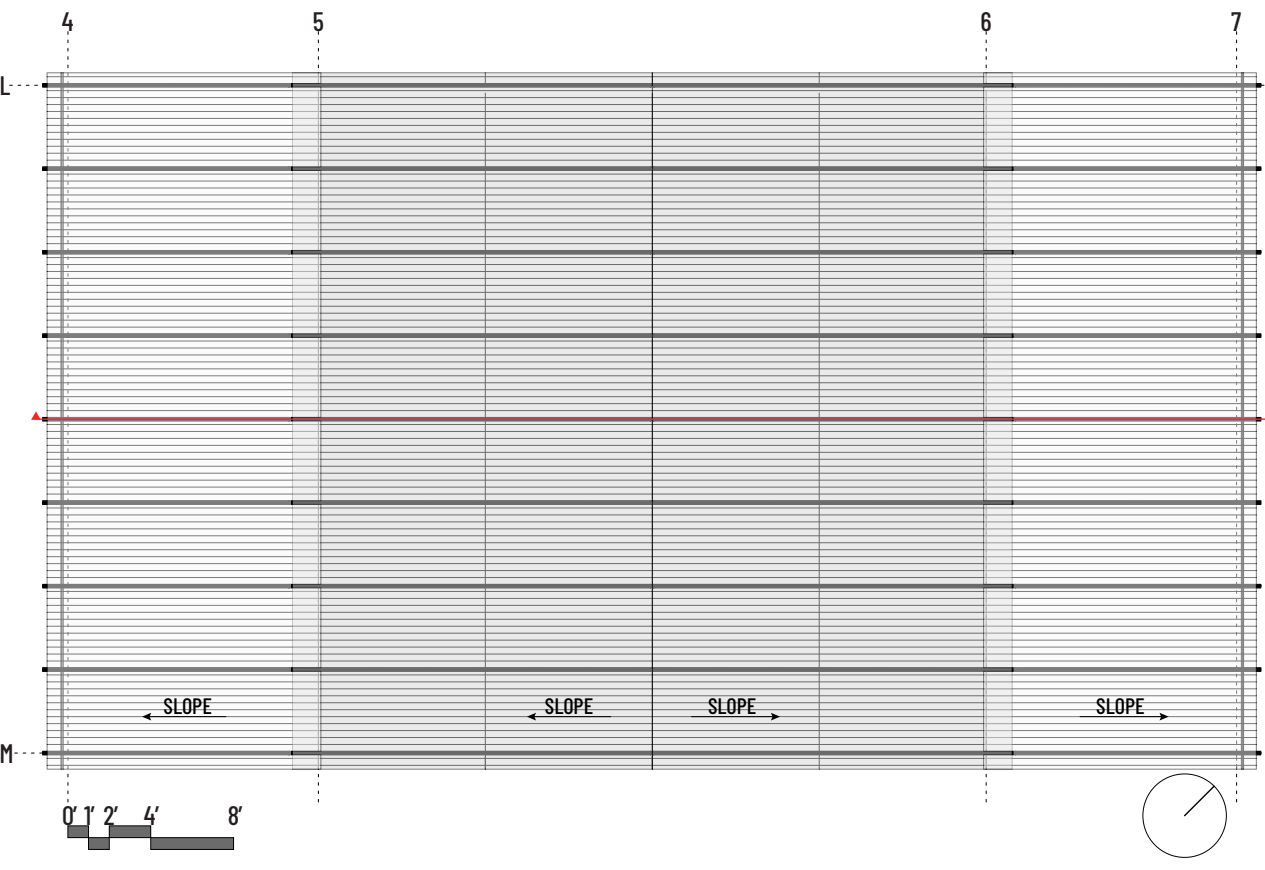

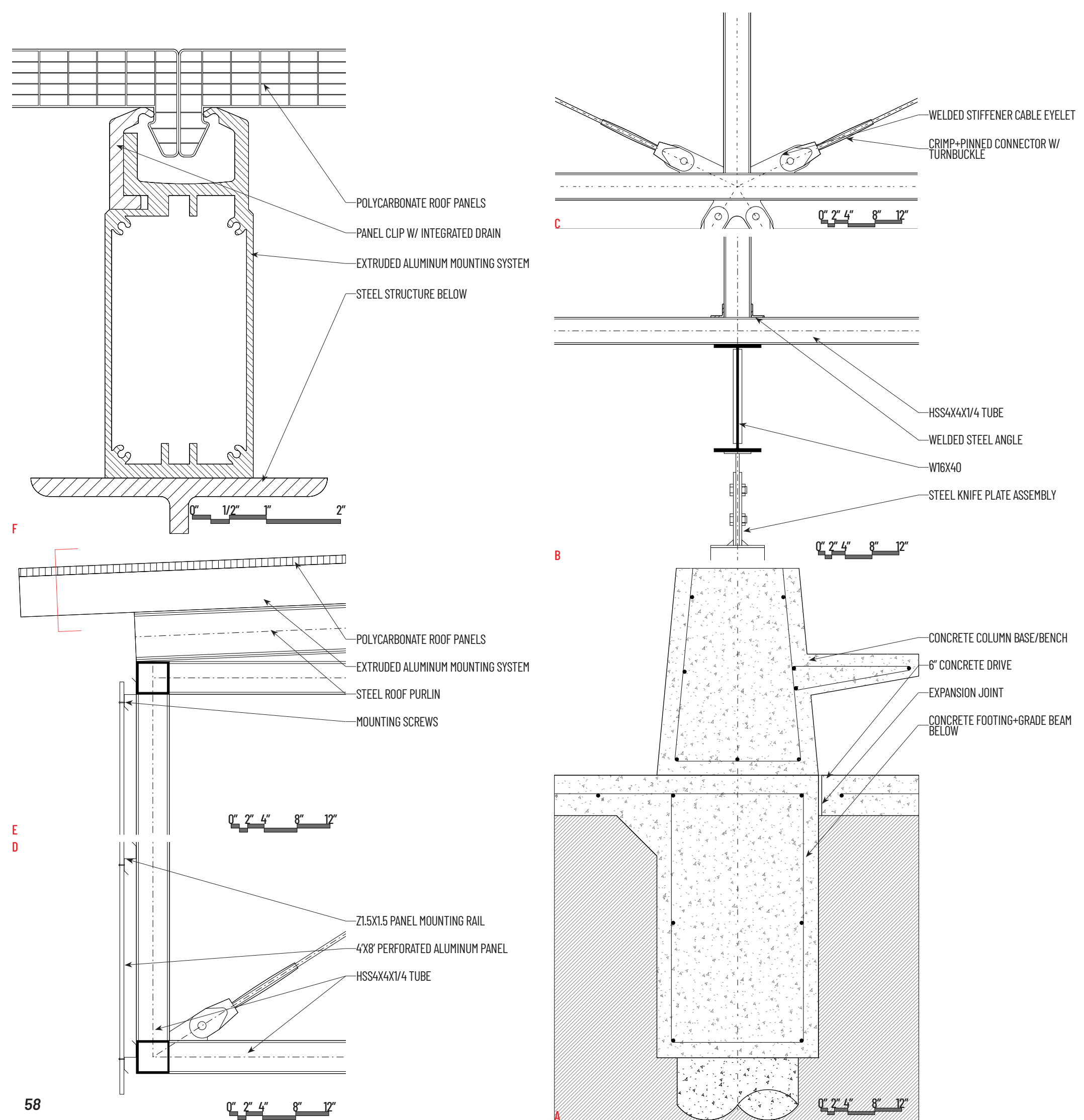

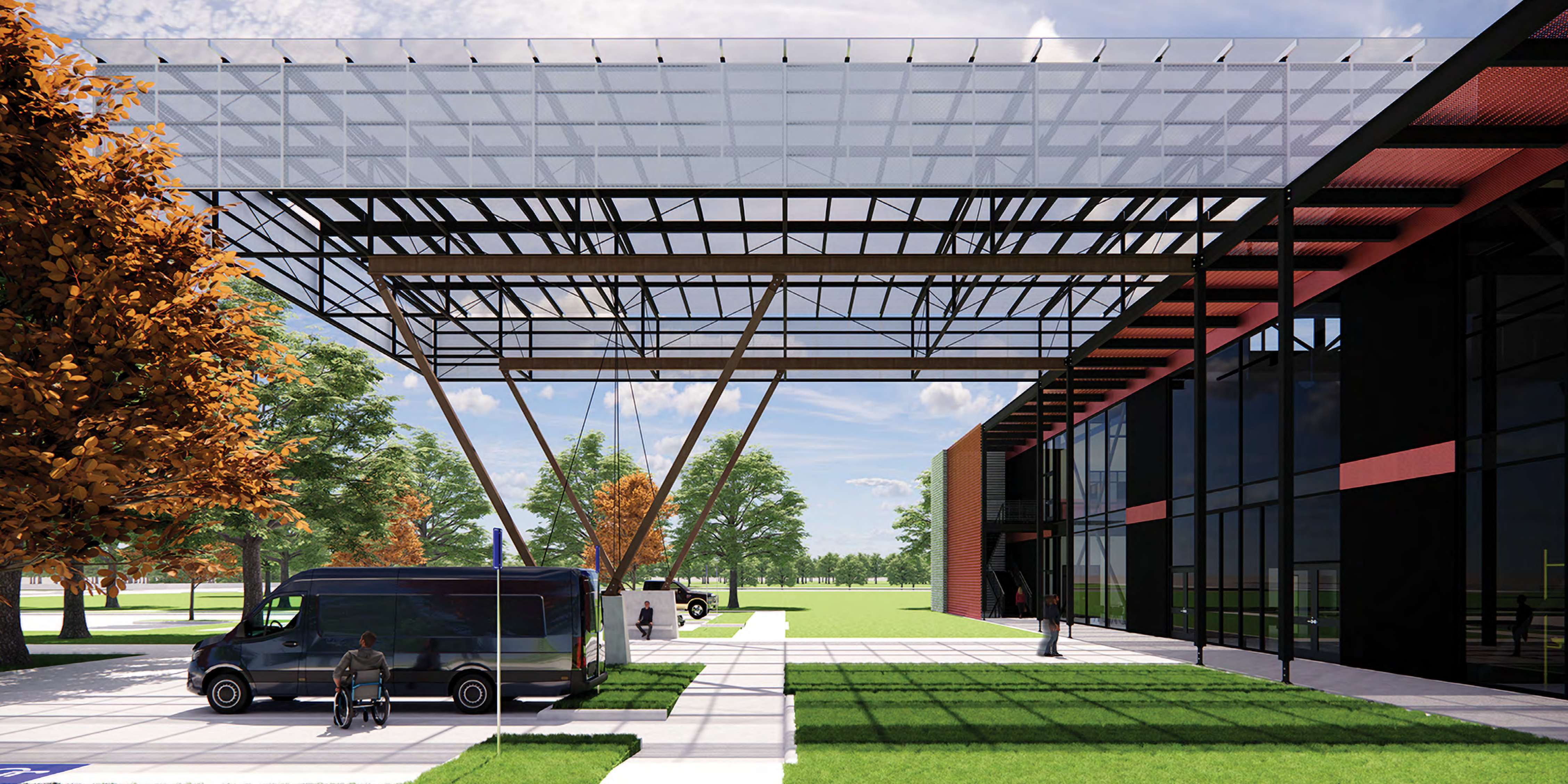

WELDED ASSEMBLY

The 64' truss supporting the administration meets in the center with a gusset plate uniquely different from other plates seen in the project but attaches with the standard knife plate system utilized on other structural connections in the building. This center connection creates part of the prominent truss that can be seen throughout the building.

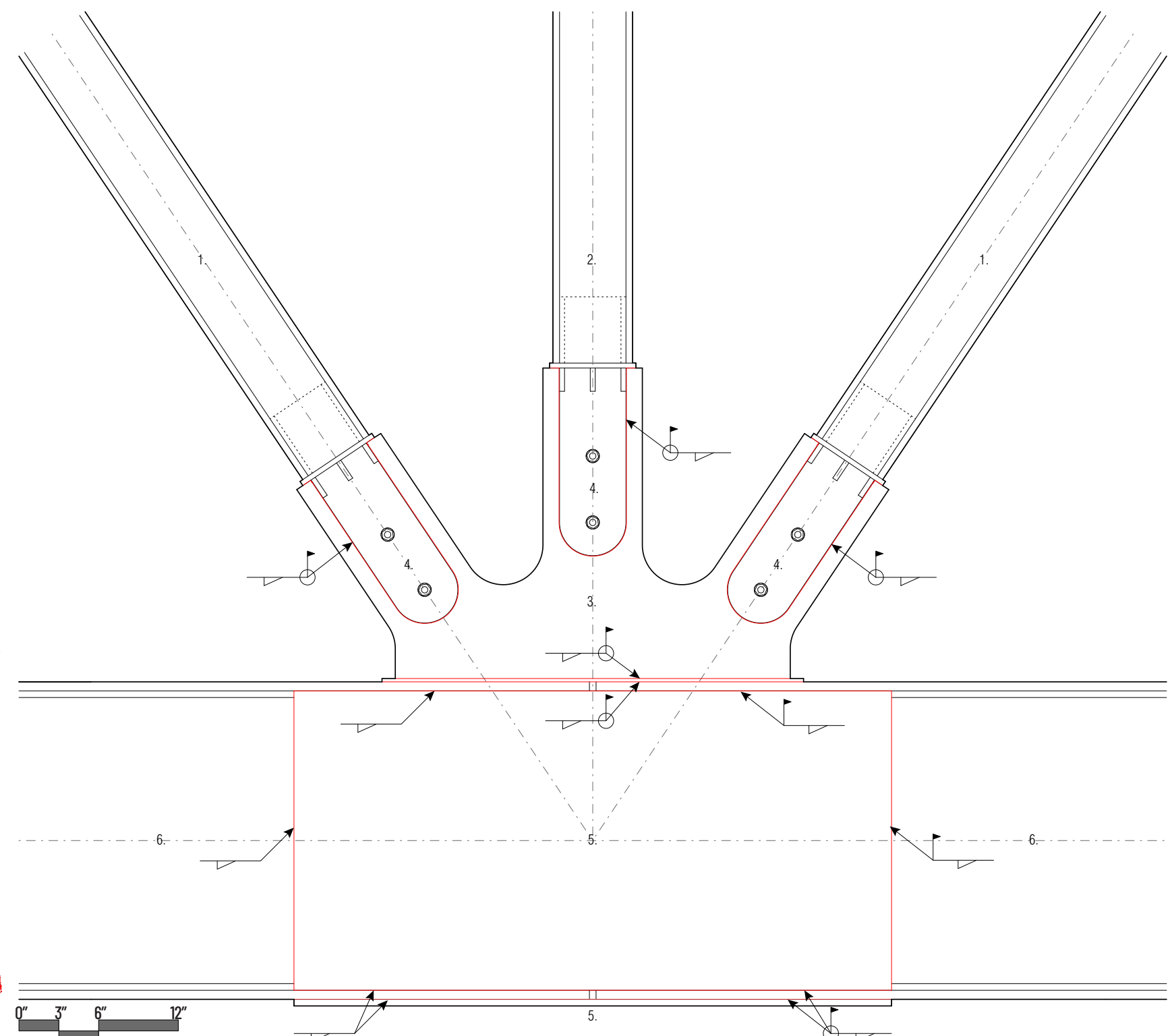
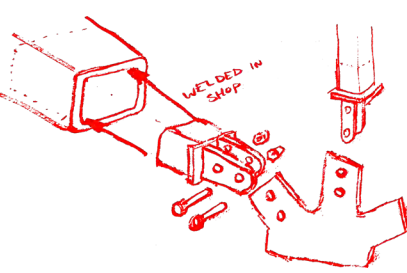
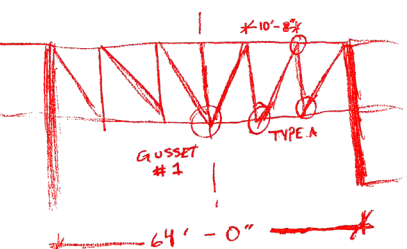

- 1 6X4X1/2 HSS TUBE
- 2 6X6X5/8 HSS TUBE
- 3 GUSSET PLATE WITH MALE CONNECTOR
- 4 KNIFE PLATE WITH FEMALE CONNECTOR*
- 5 WELDED GIRDER SPLICE PLATE
- 6 W24X76 GIRDER

*BOLTS TEMPORARILY HOLD STEEL IN PLACE TO ASSIST WELDING PROCESS

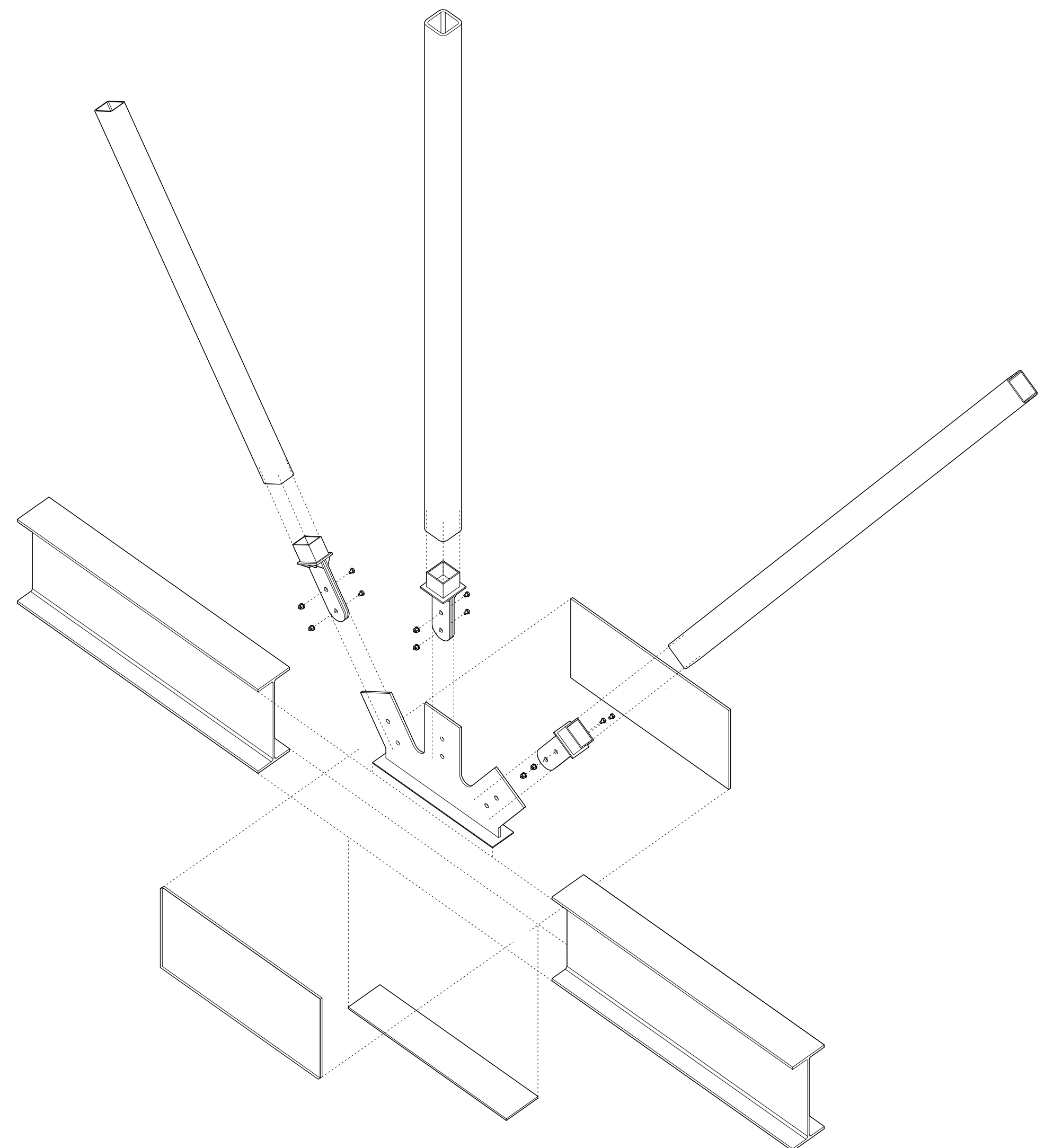
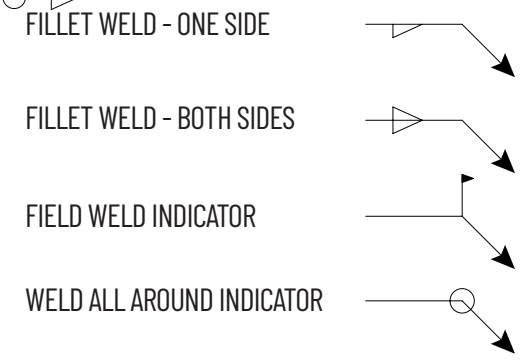



WELDED ASSEMBLY

A repeated element is the moment connection between the columns and girders. This condition appears in locations where the steel is not hidden from view. The girders are first bolted to provide temporary support and welds are added after, with the bolts remaining.

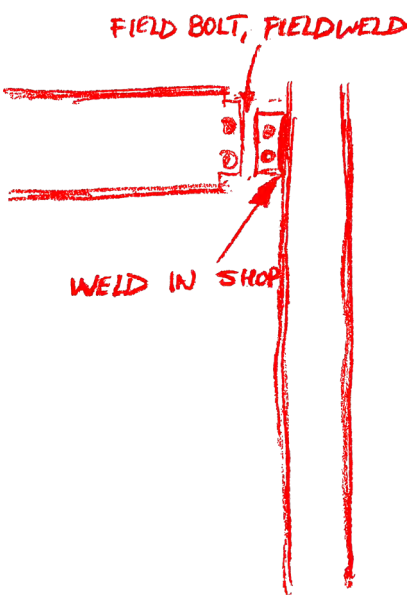
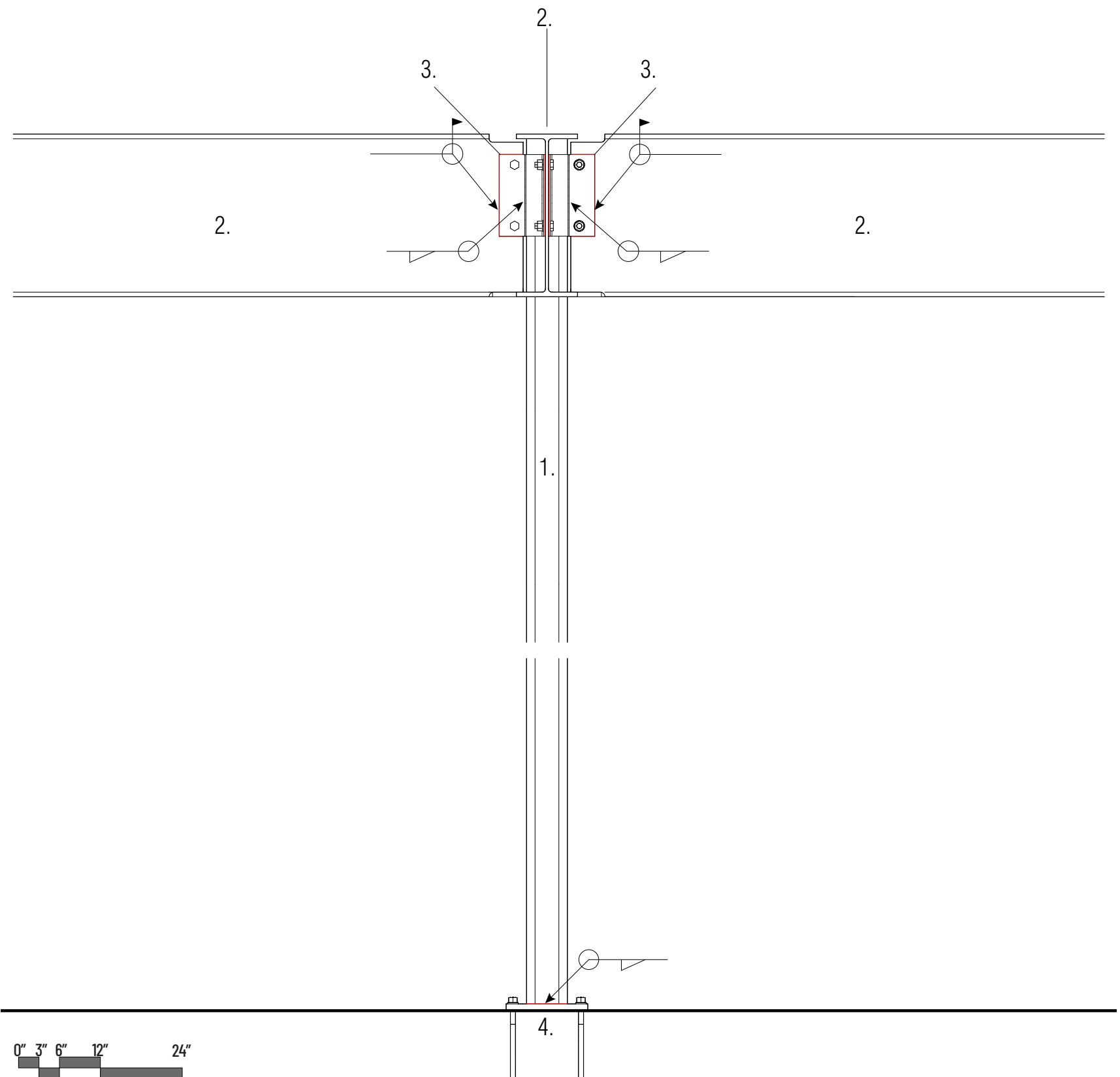

- 1 6X6X1/2 HSS TUBE
 - 2 W16X40 GIRDER
 - 3 SHOP-WELDED TAB, 2 BOLT HOLES*
 - 4 SHOP-WELDED BASE PLATE, 4 BOLT HOLES, CONCRETE-EMBEDDED THREADS
- *BOLTS TEMPORARILY HOLD STEEL IN PLACE TO ASSIST WELDING PROCESS

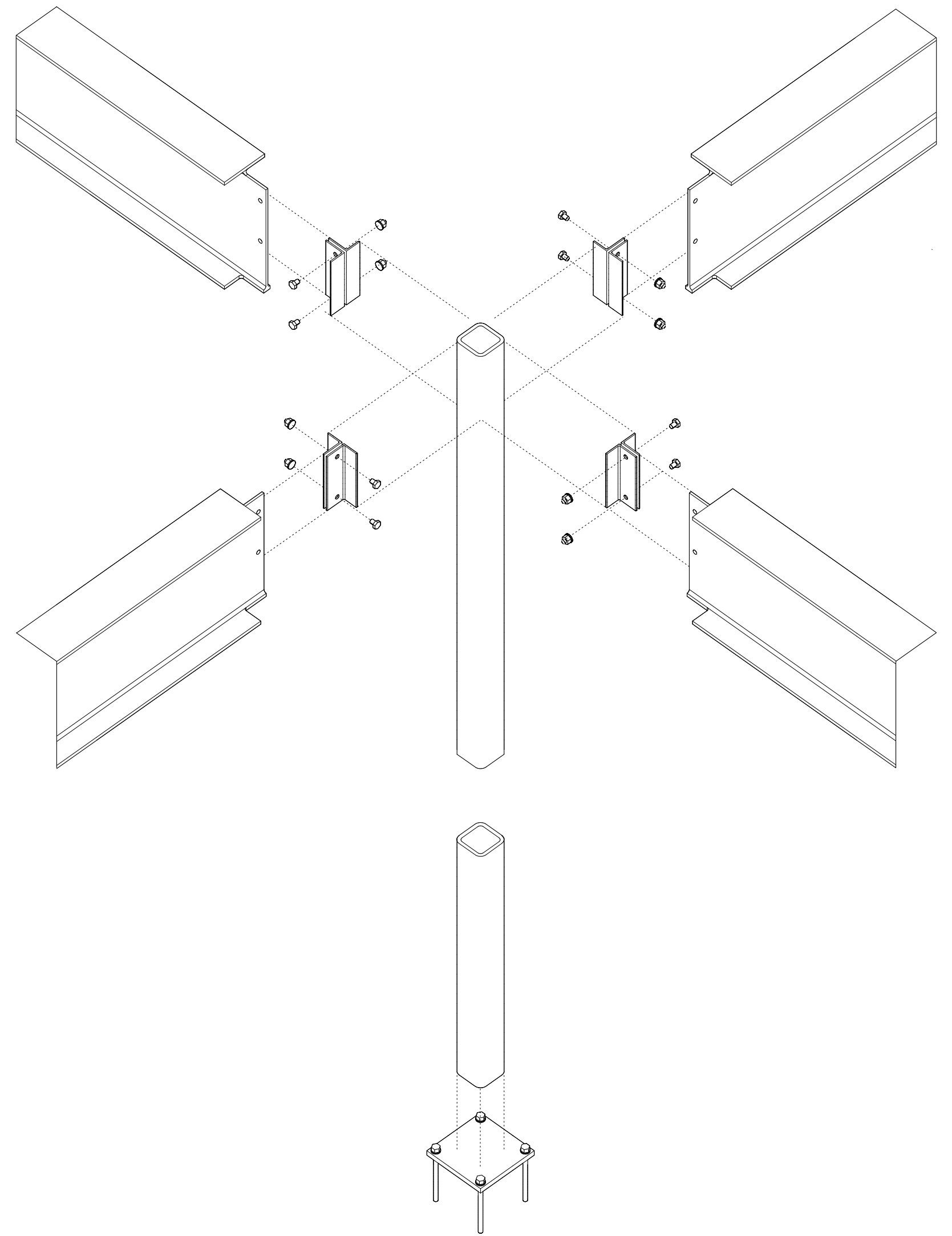
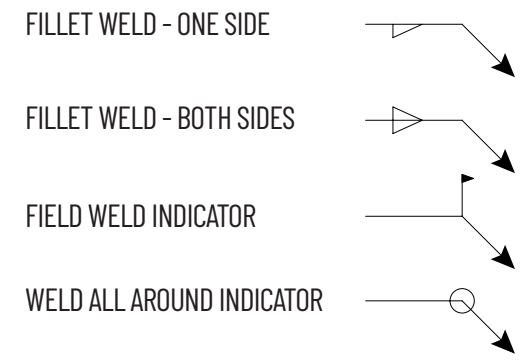

WELDED ASSEMBLY

Two prominent wind braces are visible on the front of the building. These wind braces are connected with welded steel tubes and connect to gusset plates with connectors that are also seen elsewhere in the structure. These repeated elements are one example of an effort to utilize reusable, standardized elements in multiple locations.

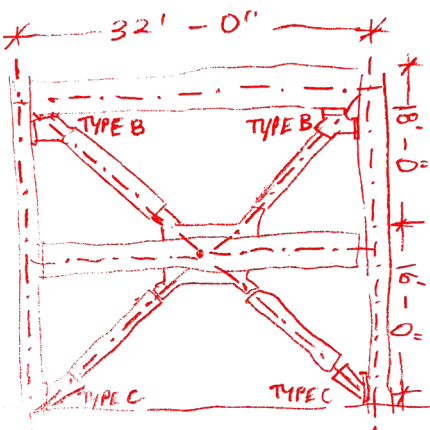
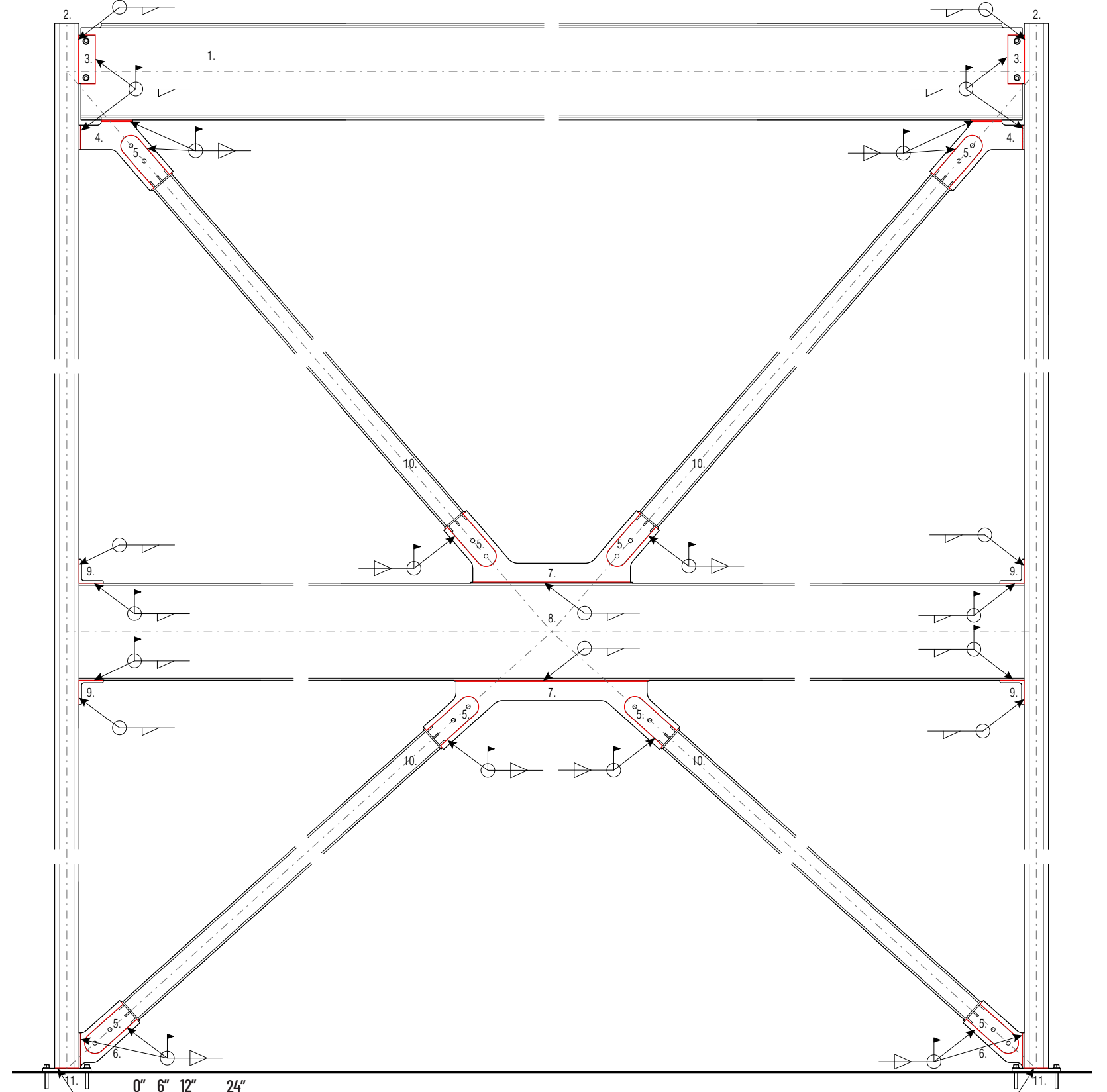

- 1 W24X76 GIRDER
- 2 6X6X5/8 HSS TUBE
- 3 SHOP-WELDED TAB, 2 BOLT HOLES*
- 4 CORNER GUSSET PLATE TYPE B
- 5 KNIFE PLATE W/ FEMALE CONNECTOR*
- 6 CORNER GUSSET PLATE TYPE C
- 7 GUSSET PLATE, 2 CONNECTORS
- 8 24X6X1/4 HSS TUBE
- 9 WELDED ANGLE GIRDER SEAT
- 10 6X4X1/2 HSS TUBE
- 11 SHOP WELDED BASE PLATE, 4 BOLT HOLES, CONCRETE-EMBEDDED THREADS

*BOLTS TEMPORARILY HOLD STEEL IN PLACE TO ASSIST WELDING PROCESS

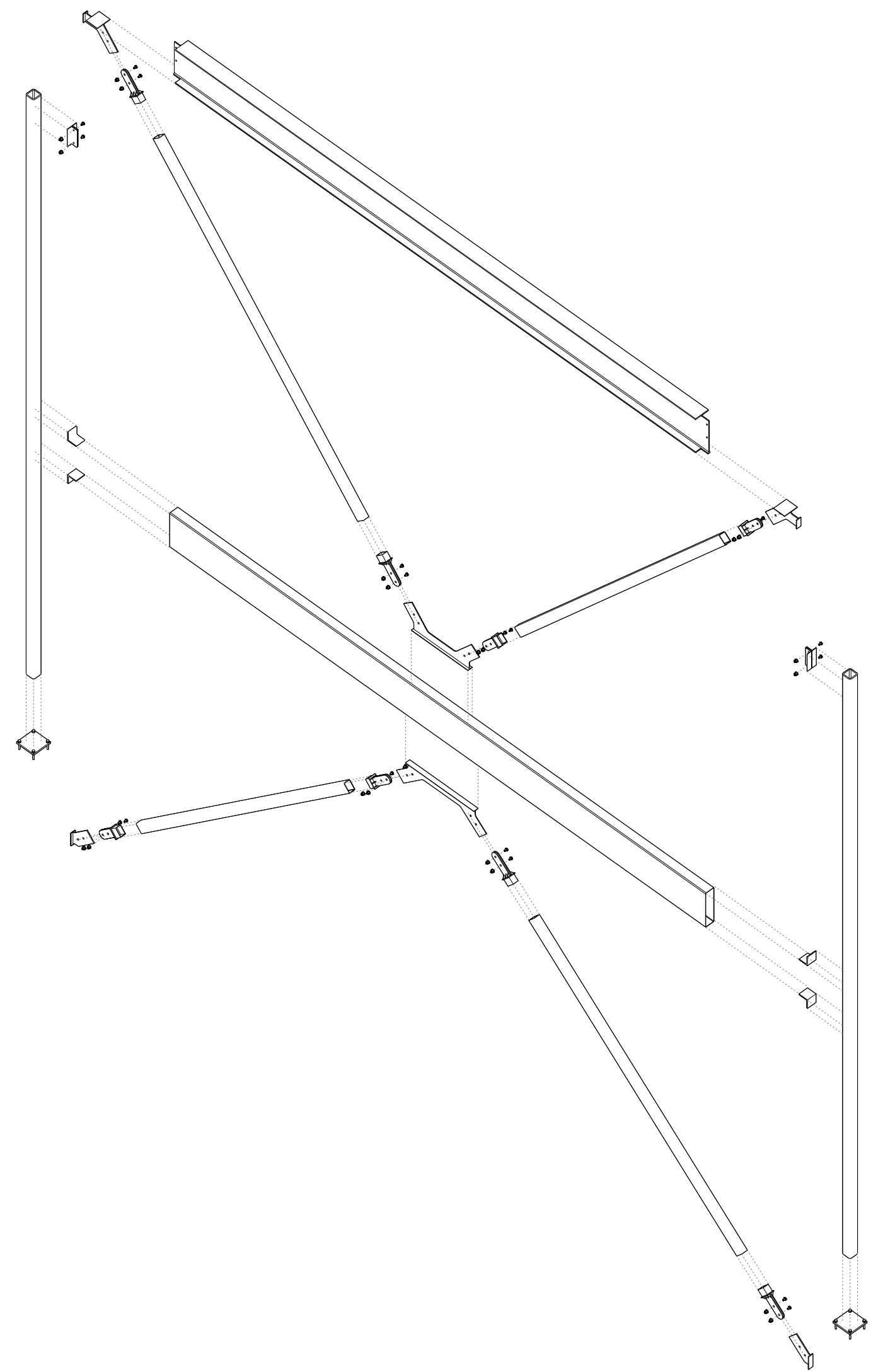
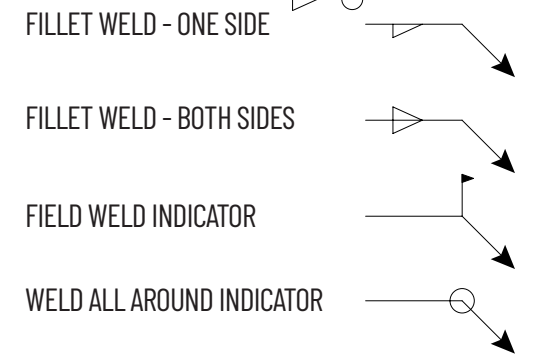





CAUTION
THIS MACHINE
HAS NO BRAIN
USE YOUR OWN

WALL ASSEMBLY

The wall construction of the building follows a standard formula for assembly, and is encased in metal paneling all around. Sleek black metal acts as a base for the red metal, which runs in two bands around the building highlighting each level of steel supporting the second floor and roof. In the atrium space, the black paneling switches to white to highlight the change of space and subtractive effect from the overall mass. The panels are mounted using a system that takes inspiration from the Zahner Drop&Lock technology, allowing panels to be slid into place along a perforated track.

The choice to use metal panels ties back to the building's purpose in educating on the art and craft of welding and related manufacturing skills. The panels follow a complicated but consistent grid system, following a language created by extracting the building's major datums to panelize the exterior facade. The perforated surface of the panels creates eye-catching light effects, and allows the wall assembly to breathe and regulate moisture throughout the year.

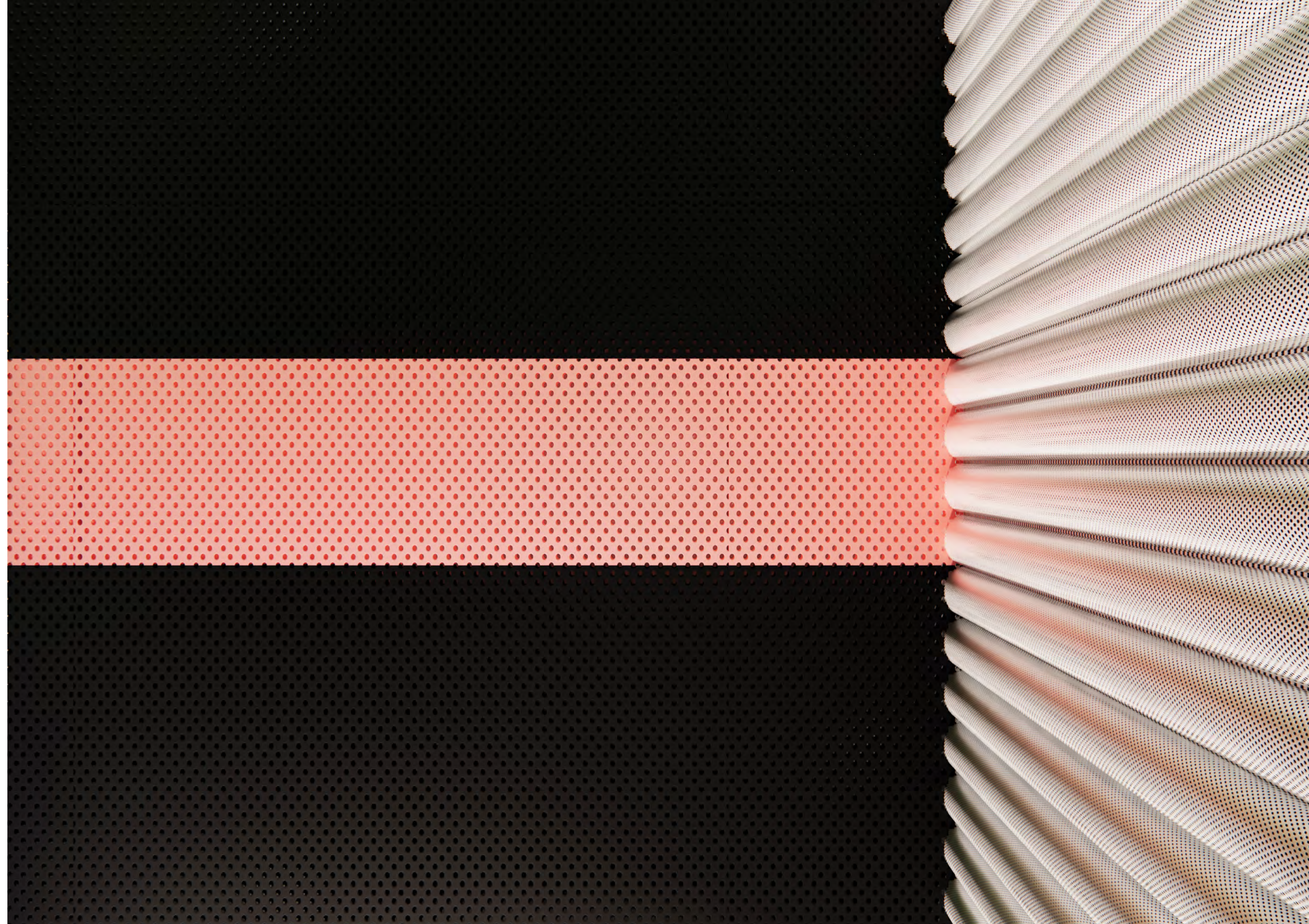

WALL ASSEMBLY

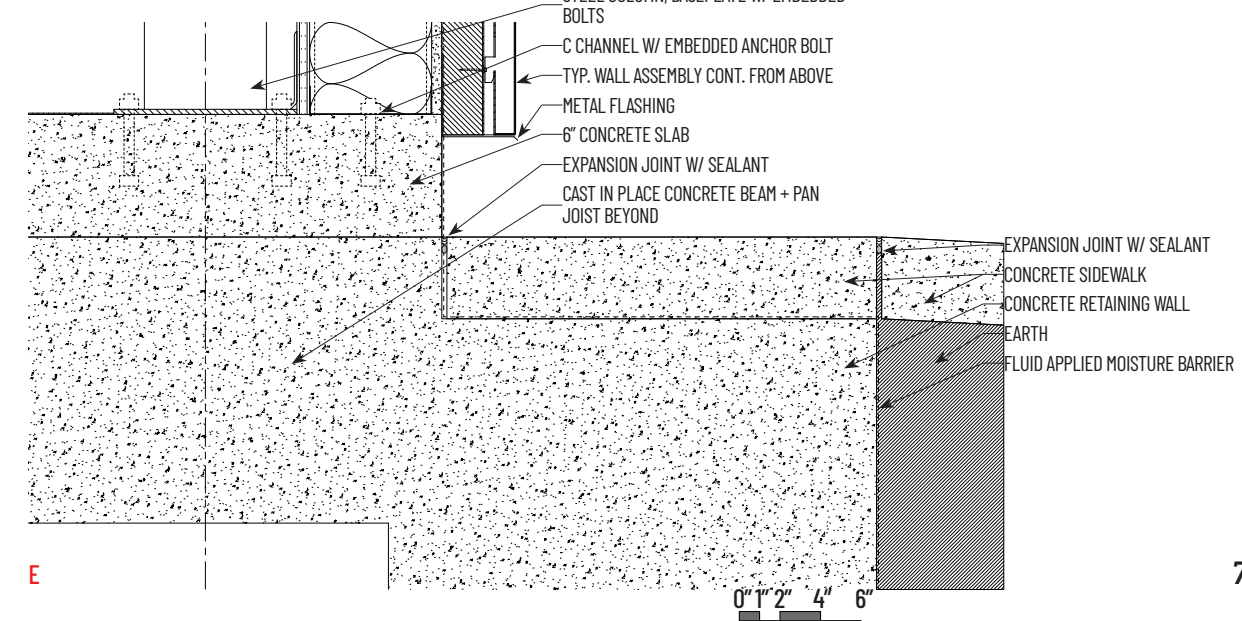
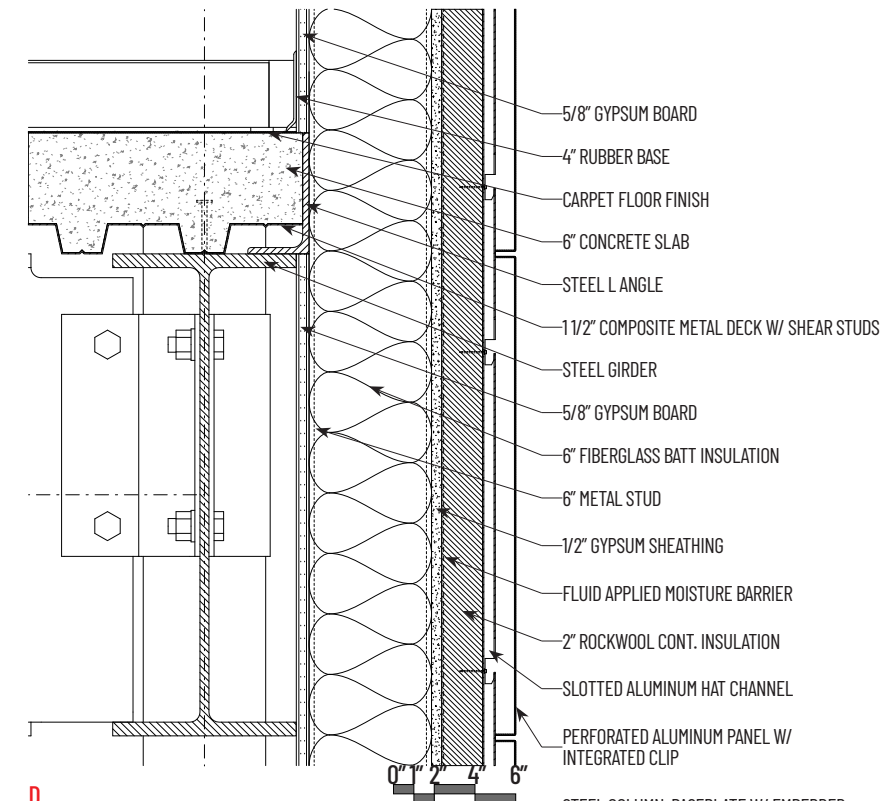
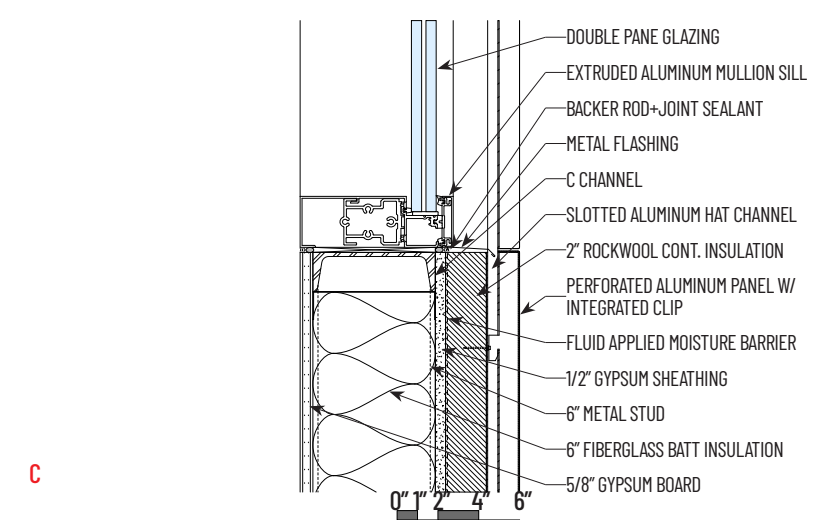
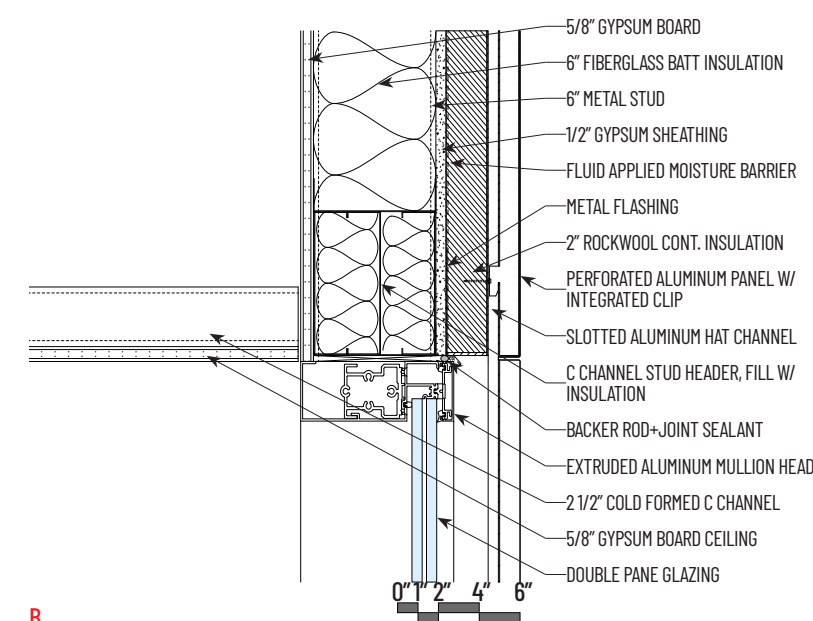
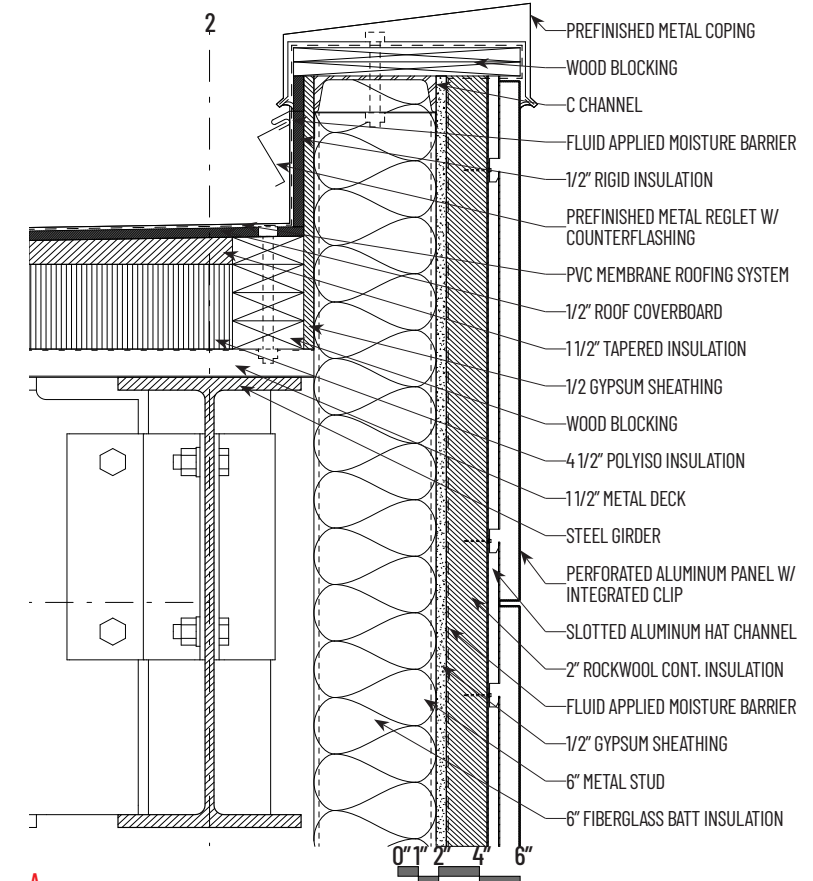
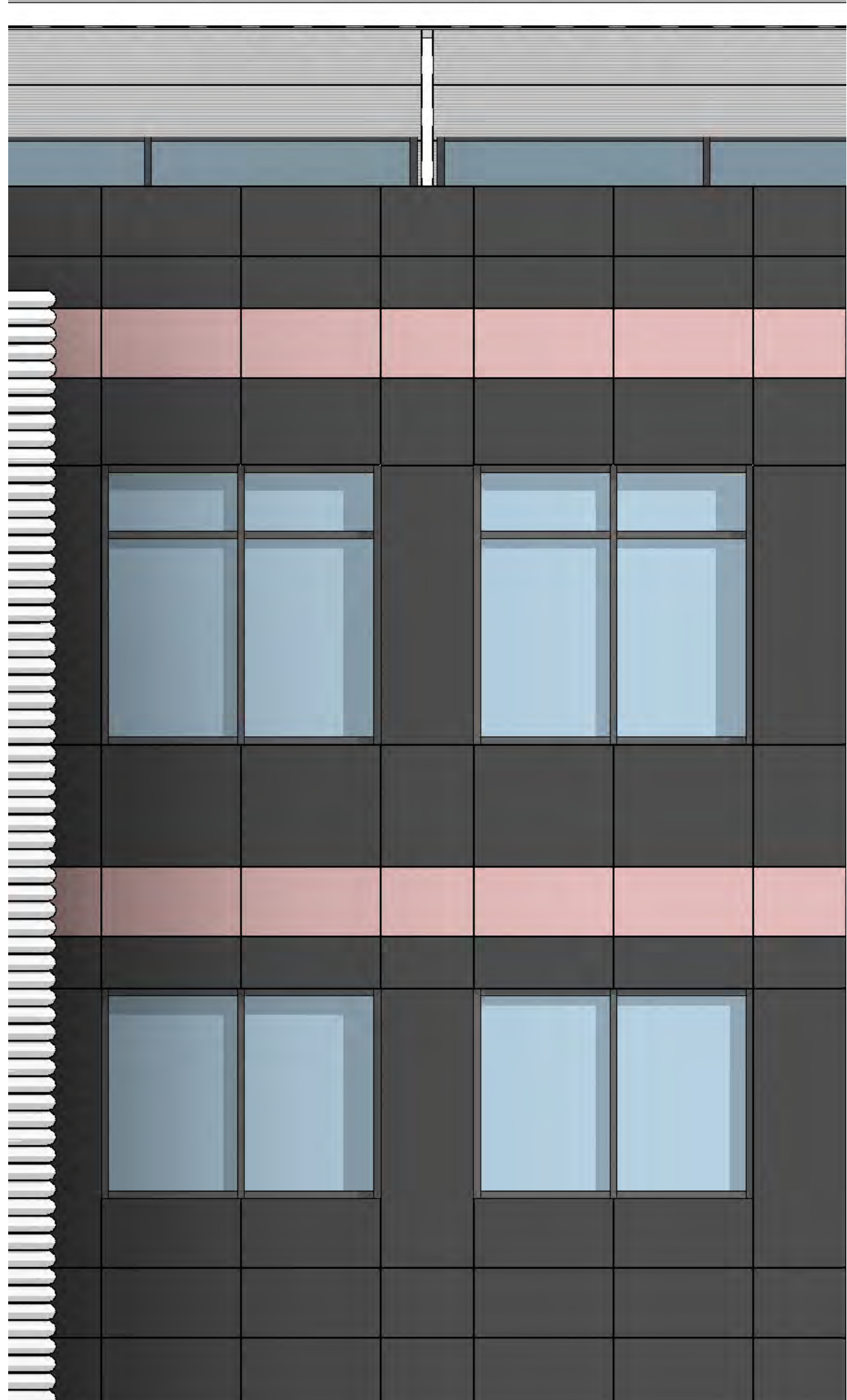
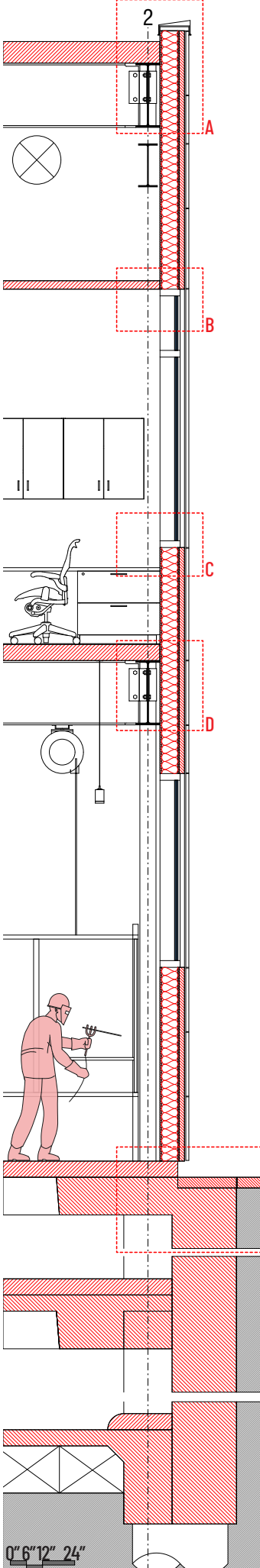

FACILITIES

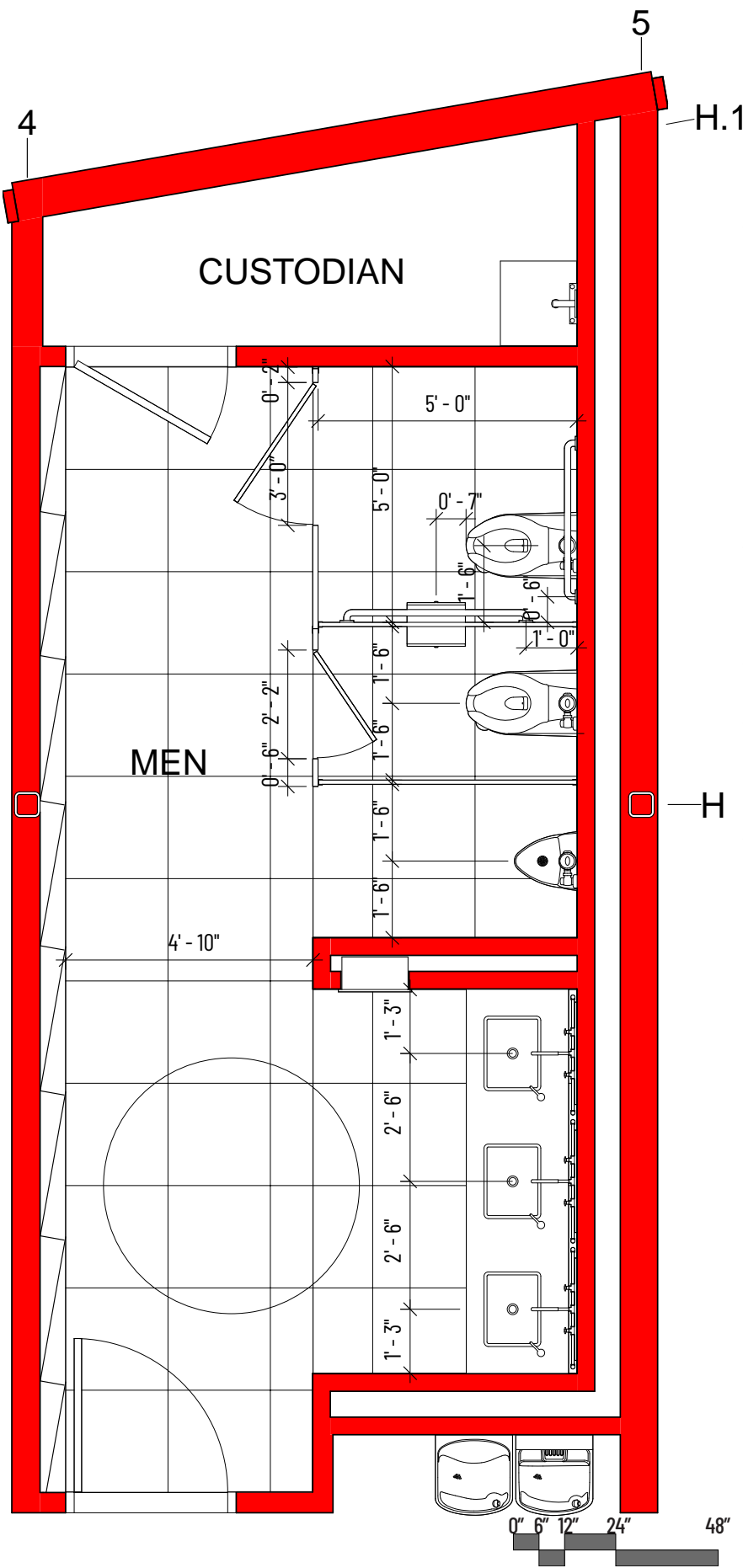

The restroom facilities are fitted neatly within the narrow bays of the structural grid and stack on each other across the two main levels. A prominent feature of the restroom spaces is the full height light wall.

In an effort to direct some of the overhead light onto a different plane, a series of angled faces peeling off the empty wall of the circulation space was devised. As with the theme elsewhere in the building, steel was the obvious material choice. These wedge-shaped pieces are constructed from steel plates and on the open end reveal full-height led panels that cast a glow in the space. A small raised piece on the base serves as a cane detection device and grounds the assembly to the floor.

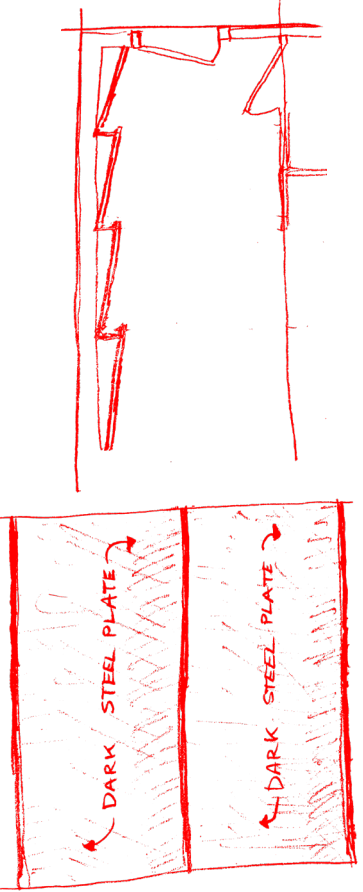





MECHANICAL CONCEPTS

The structural grid creates an order within which the mechanical systems are housed and supply air to the major spaces.

Rooftop units are placed on the main roof, protected by the large butterfly roof projection along the central spine of the building.

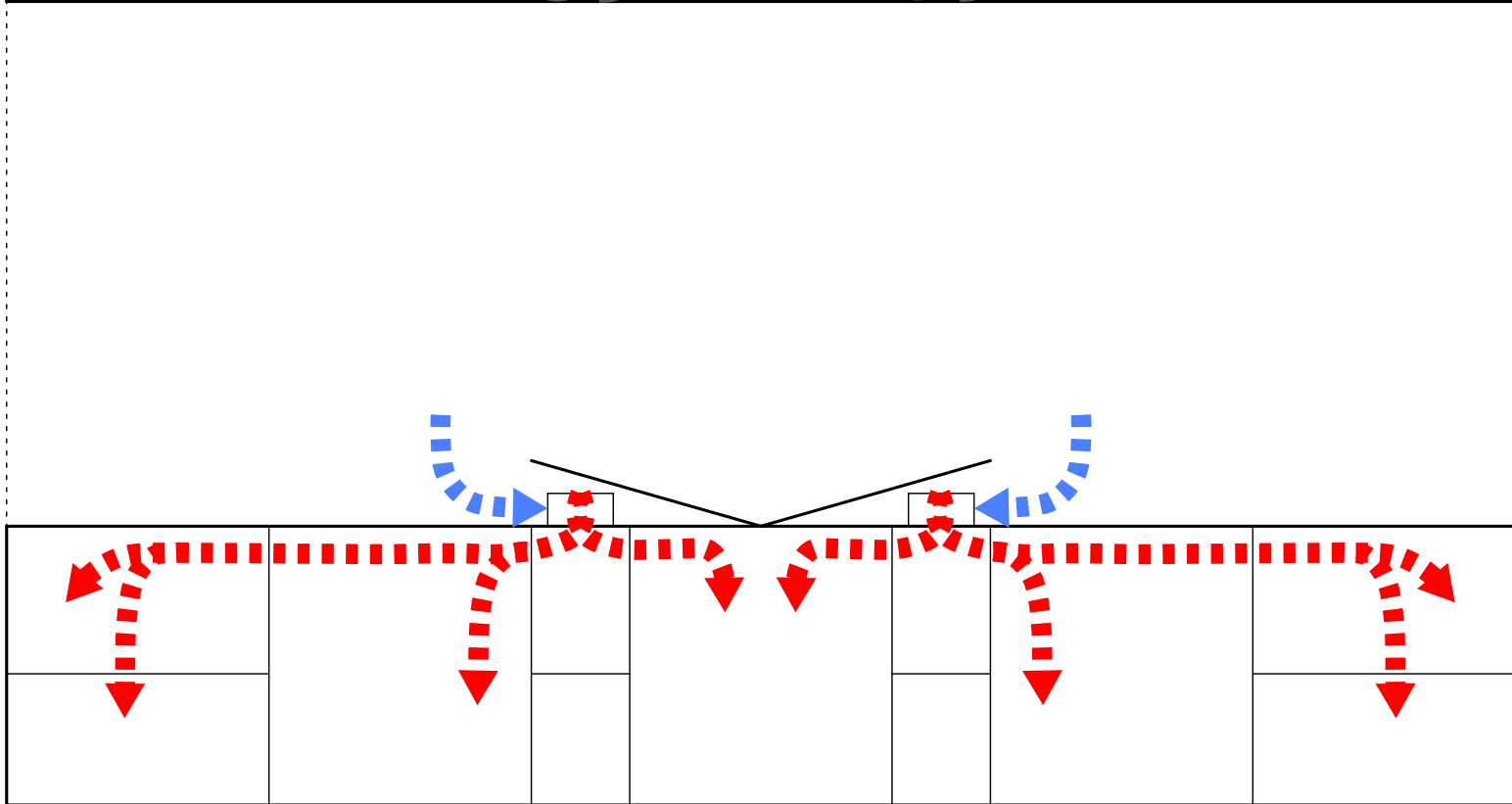
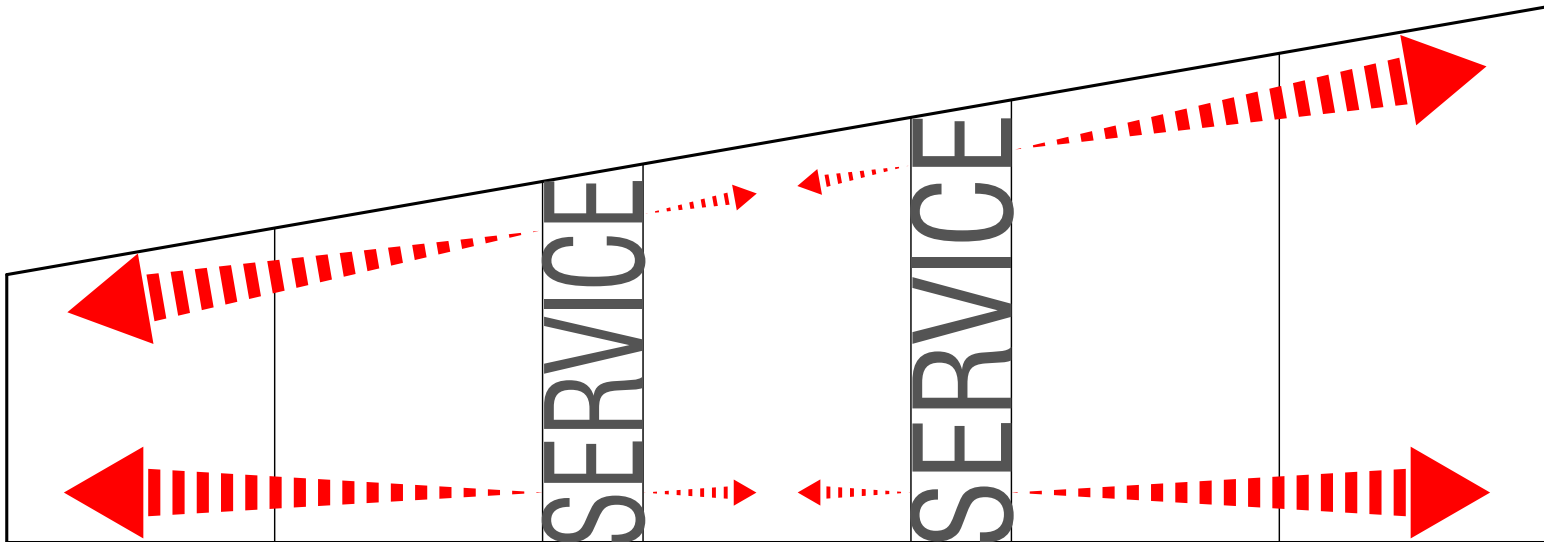
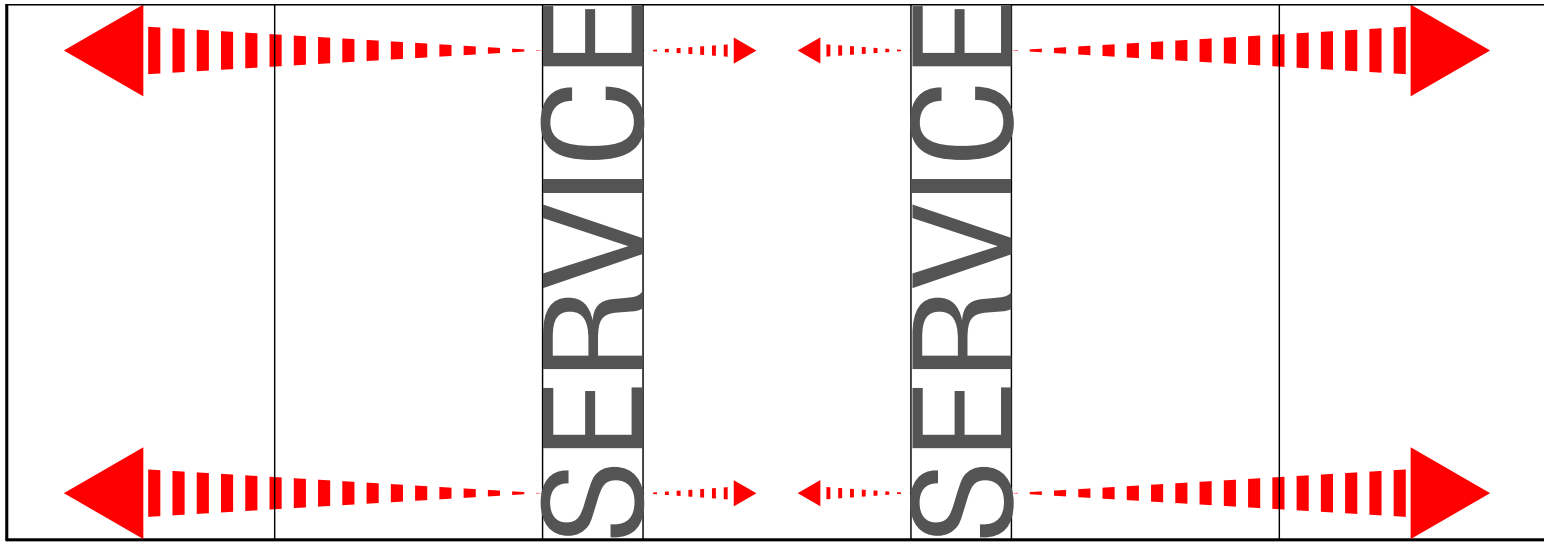
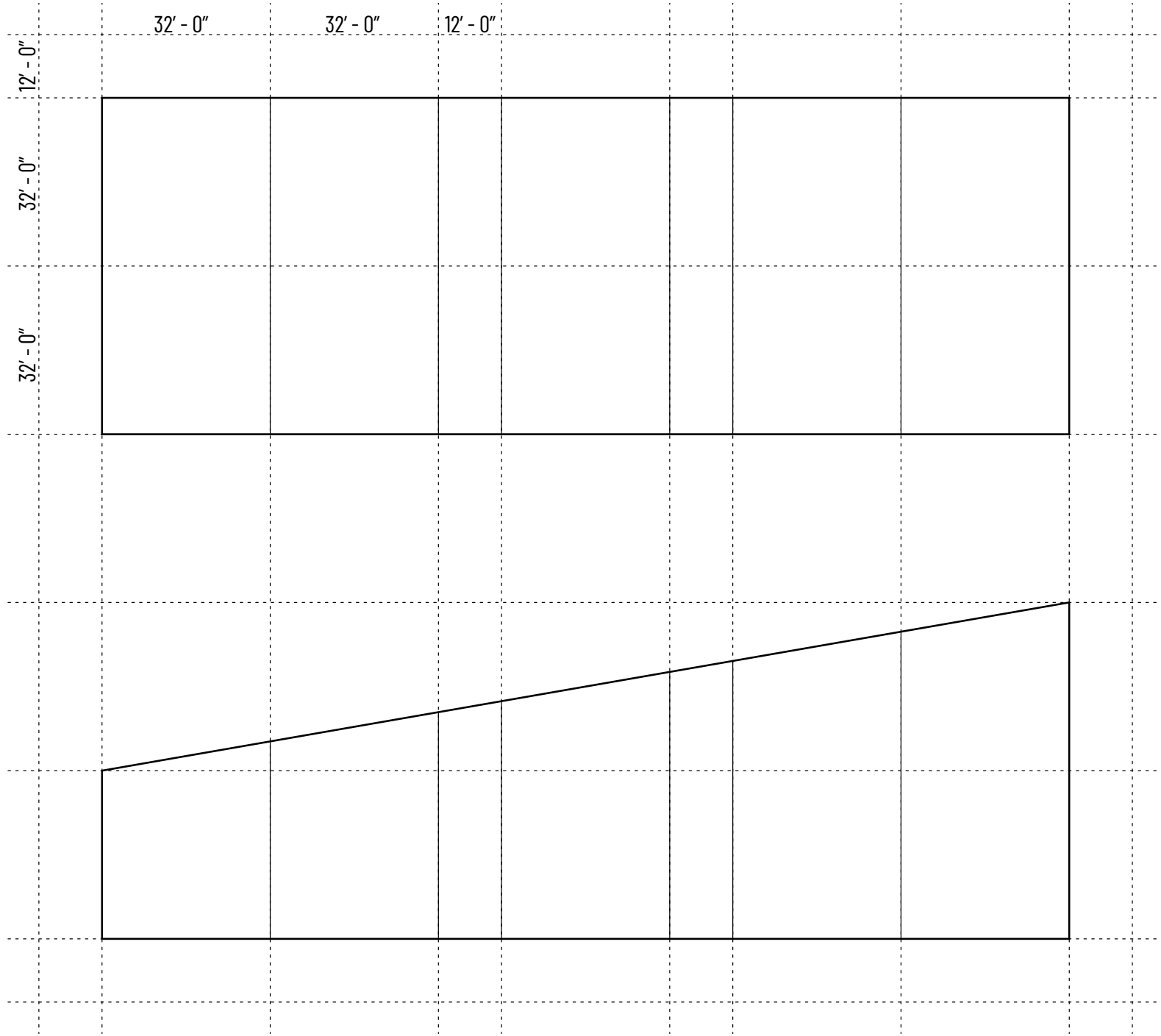



REFSOLUTION

FINAL THOUGHTS

THE PROJECT

The issue of revitalizing skilled trades is a lengthy, multi-variable task that is bigger than any one person or organization, and this project seeks to provide one small part of the solution to a very large problem. I recognize that this is not a “one size fits all” solution, but that it may point to a possible avenue for addressing the declining trades and how collegiate programs and local school districts can work together to foster new excitement and awareness for the benefits and honorable professions that can be had in the skilled trades.

TO FUTURE M.ARCH STUDENTS

Do not shy away from diving deep into your project and absorbing as much as you can from your professors, peers and research. An important lesson that I took away from this year-long endeavor is that it is largely up to you to take the project as far as you are willing to let yourself take it, with your studio and committee guiding your efforts. Go the extra mile, since this is likely your last academic project ever before entering the professional practice. Embrace it, enjoy it, be obsessed with it.

Be aware of your position in the program and the college at large. Just as the previous classes were for me, you are also an inspiration to and resource for your peers and the classes that come after you. They will appreciate your advice, input and Aggie hospitality, even if they may be too shy to approach you for it. Be a tutor to someone struggling in an area you are good at. It is a rewarding position to take on, and improves the overall skill level of the class. Lastly, don't forget to have fun when you can. The final study year is intensive and lots of work, but it flies by in an instant. Remember to enjoy it and make time for other important things in your life, too.

LESSONS LEARNED

-Trust the process, even if the situation seems untenable at times.

-Go with what you know. Learning a new software in a hurry ended up wasting more time than if I had just stuck to the software I already knew how to use. In other words, if it ain't broke, don't fix it.

-Sometimes you have to make a few more iterations, and that is ok. It is part of the design process, even though it may be frustrating.

-Always back up your files, even if you don't think you need to. You will thank yourself later.

-Always come with new drawings to show, and even if you can't, have questions and ideas to discuss. Your time in studio is critical to the advancement and success of your project.

-Grids. Use them. They are your friend.

-Understand what workflow is appropriate for the deliverables being asked for. Don't create avoidable setbacks by creating final-quality work for an interim drawing pin-up.

RESOURCES + IMAGES

Adler, M. J. (1999). *The great ideas: A lexicon of western thought*. Scribner Classics.

Blaser, W. (1986). *Mies van der rohe: Less is more*. Waser.

Blaser, W. (1997). *Mies van der rohe*. Birkhäuser.

Bousquin, J. (2022, September 1). *Lack of construction workers threatens infrastructure efforts: AGC*. Construction Dive. <https://www.constructiondive.com/news/construction-worker-shortage-threatens-ijja-infrastructure-investments-agc/631017/>

Haviland, S., & Robbins, S. (2021, April 11). *Career and Technical Education as a Conduit for Skilled Technical Careers: A Targeted Research Review and Framework for Future Research*. Wiley Online Library. <https://doi.org/10.1002/ets2.12318>

Mills, M. P. (2023, March 3). *Are skilled trades doomed to decline?*. Manhattan Institute. <https://manhattan.institute/article/are-skilled-trades-doomed-to-decline>

Phillips, Z. (2022, November 10). *Do people not want to work (in construction) anymore?*. Construction Dive. <https://www.constructiondive.com/news/round-table-do-people-not-want-to-work-construction-anymore/636271/>

Woodruff, J., & Solman, P. (2021, January 28). *Despite rising salaries, the skilled-labor shortage is getting worse*. PBS. <https://www.pbs.org/newshour/show/despite-rising-salaries-the-skilled-labor-shortage-is-getting-worse>

Rowe, M. *About Us*. mikeroweWORKS Foundation. (n.d.). <https://mikeroweworks.org/about/>

Schloss, T. (2023, August 21). *Conversation with Trent Schloss*. personal.

Soliman, M., Russell, B. W., Waite, C., Shen, L., & Stringer, E. (2021). *Understanding the Behavior of Steel Connections with Bolts and Welds in Combination*. <https://www.aisc.org/globalassets/aisc/research-library/aisc-bolts-and-welds--march-4-2021.pdf>

TimWelds. (2021, February 21). *4 Types of Welding Explained: MIG vs TIG vs Stick vs Flux Core* [Video]. YouTube. <https://www.youtube.com/watch?v=y-OKi8oSNQ4>

Image Adapted for Cover:

Erminy, M. (2022). *Man welding a girder* [Photograph].



THIS PAGE INTENTIONALLY LEFT

RED

F E R R O U S